

IceCube-Gen2 High-Energy Array (HEA)

Claudio Kopper, University of Alberta
SAC Meeting 2015

thanks to Marek Kowalski and Jakob van Santen
(I borrowed very heavily from their slides!)

The Neutrino Universe

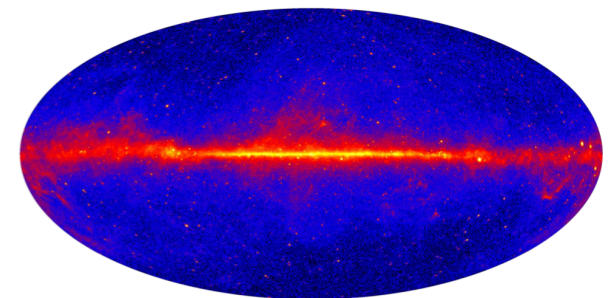
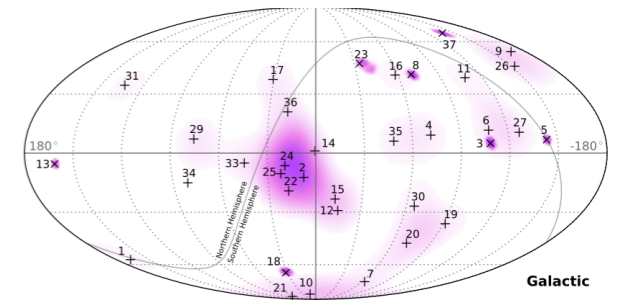
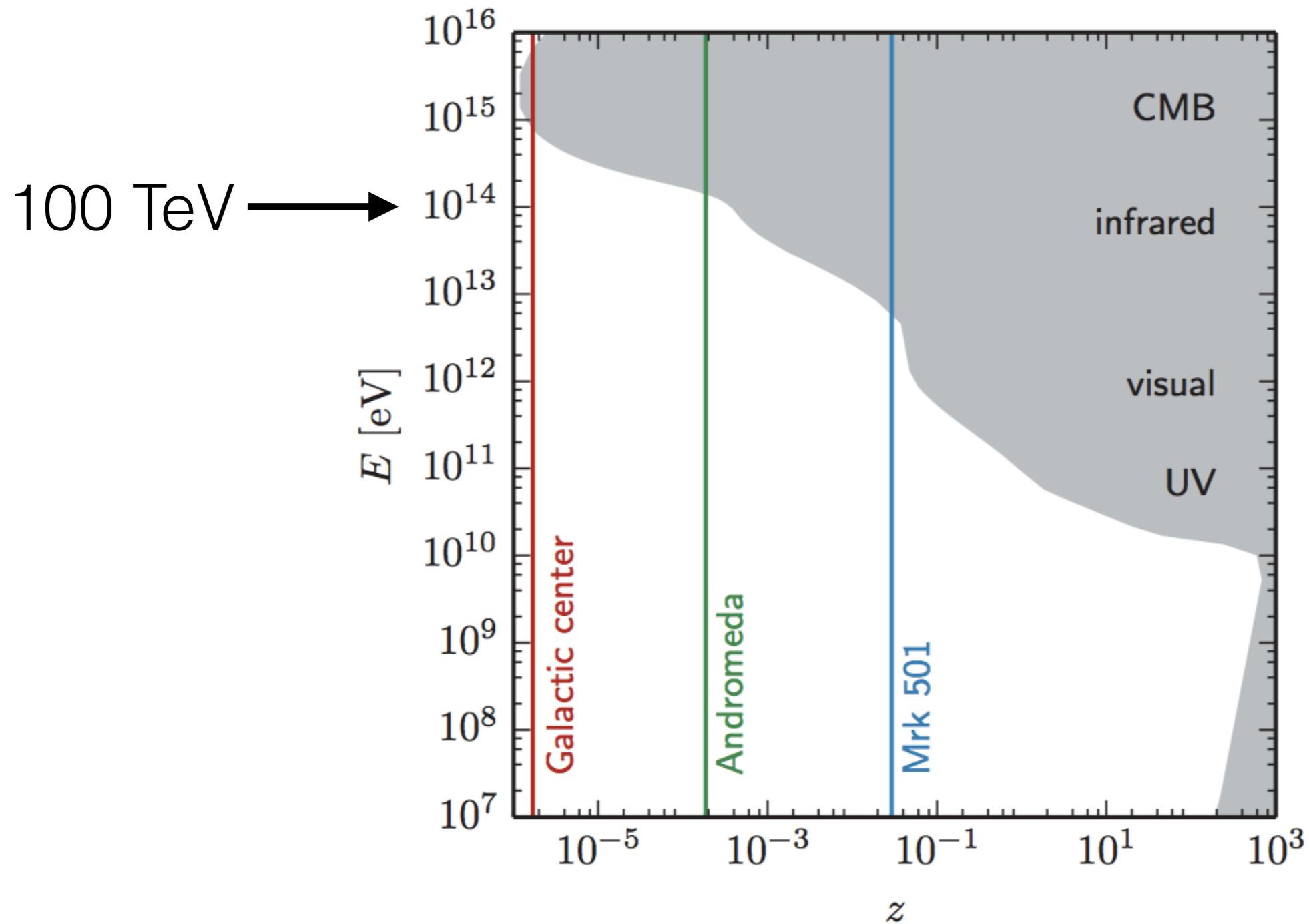

neutrino astronomy is THE window to the extragalactic Universe above 100 TeV

IceCube-Gen2 HEA

- The in-ice high-energy array of IceCube-Gen2, extending optical Cherenkov neutrino detection to higher energies - next to PINGU, a surface array (next talk), ...
- Science case:
 - Discussed by Francis this morning
 - See also the IceCube-Gen2 whitepaper: <http://arxiv.org/abs/1412.5106> (summary next slide)

Science Case

Astrophysics with Neutrinos:

- Gamma Ray Bursts
- AGNs
- Supernovae & star burst galaxies
- Cosmogenic neutrinos
- Galactic emission
- Diffuse flux (pp vs. p γ , flavor ratio, ...)

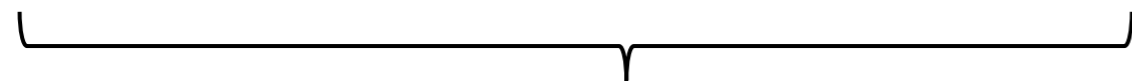

these enter our optimization

Astrophysics with gammas:

- PeV gamma ray sensitivity

Astrophysics with Cosmic Rays:

- galactic to extra-galactic transition
- Anisotropies

Particle and Nuclear Physics:

- Neutrino-Nucleon cross-sections
- Charm production cross-section
- High-pt muons?
- Massive dark matter?

Baseline

Surface: 75 km² / 100 TeV threshold (next talk)

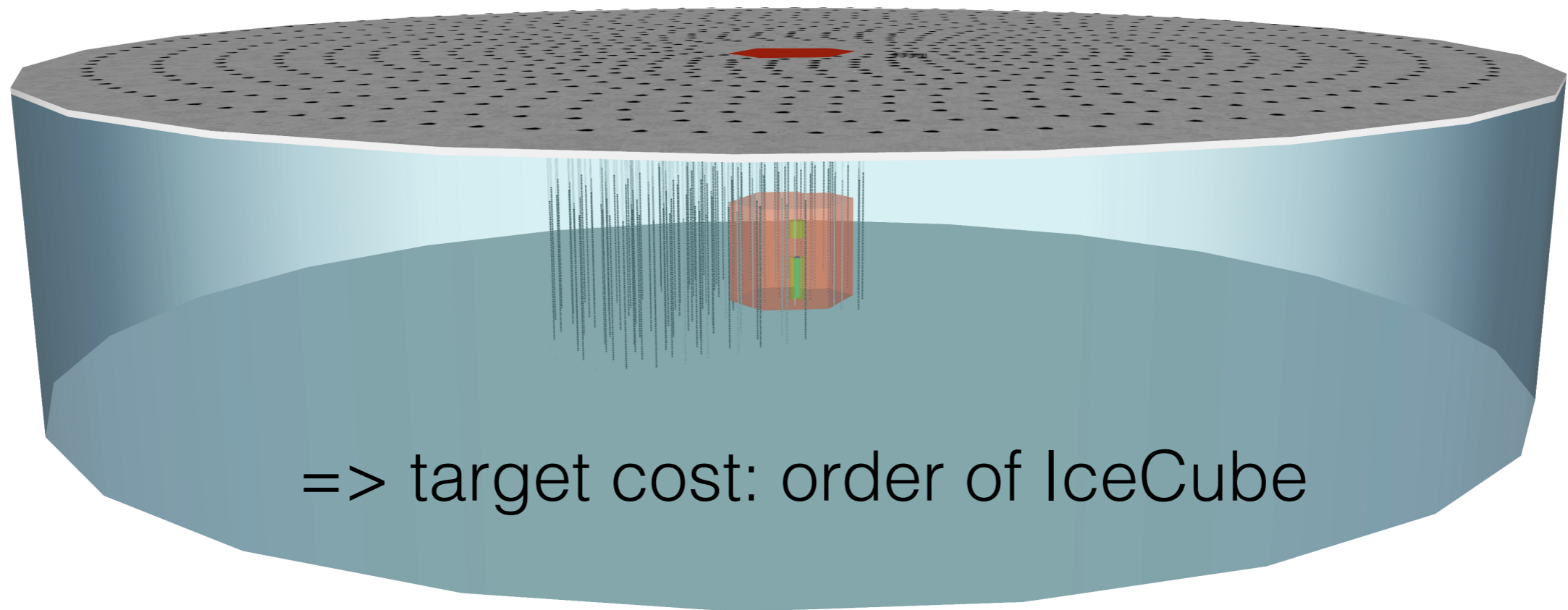

In-ice: “Sunflower” 120 strings - 240m string distance

baseline - the final detector might not look like this,
but we currently concentrate on this option

Baseline

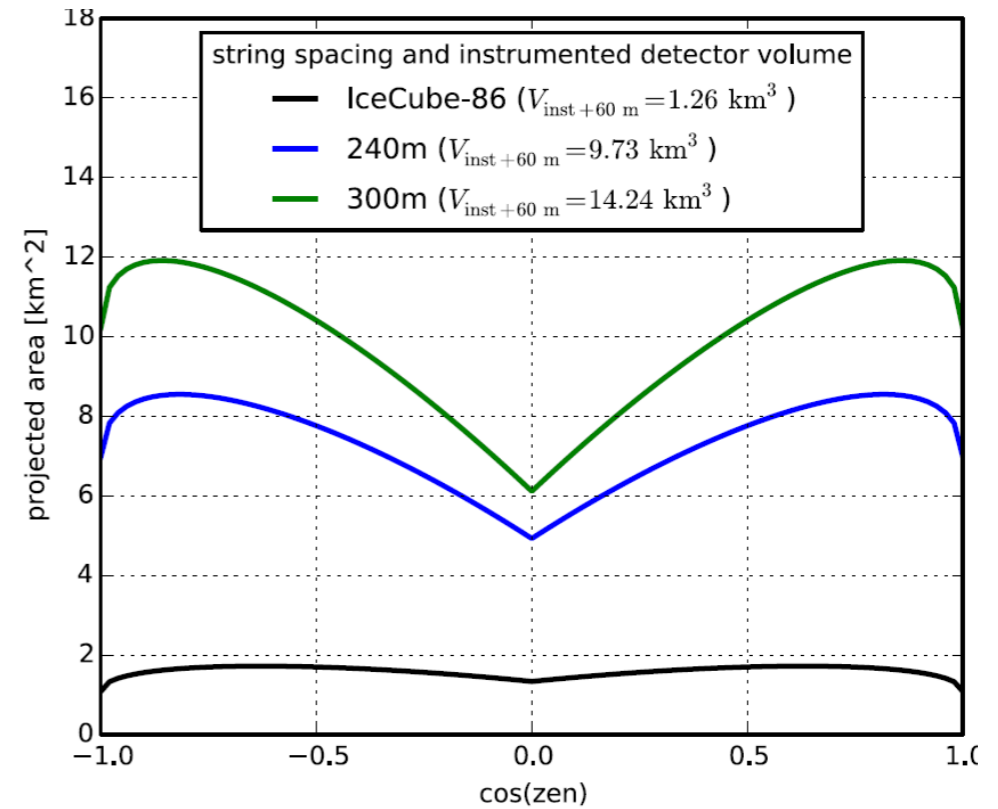
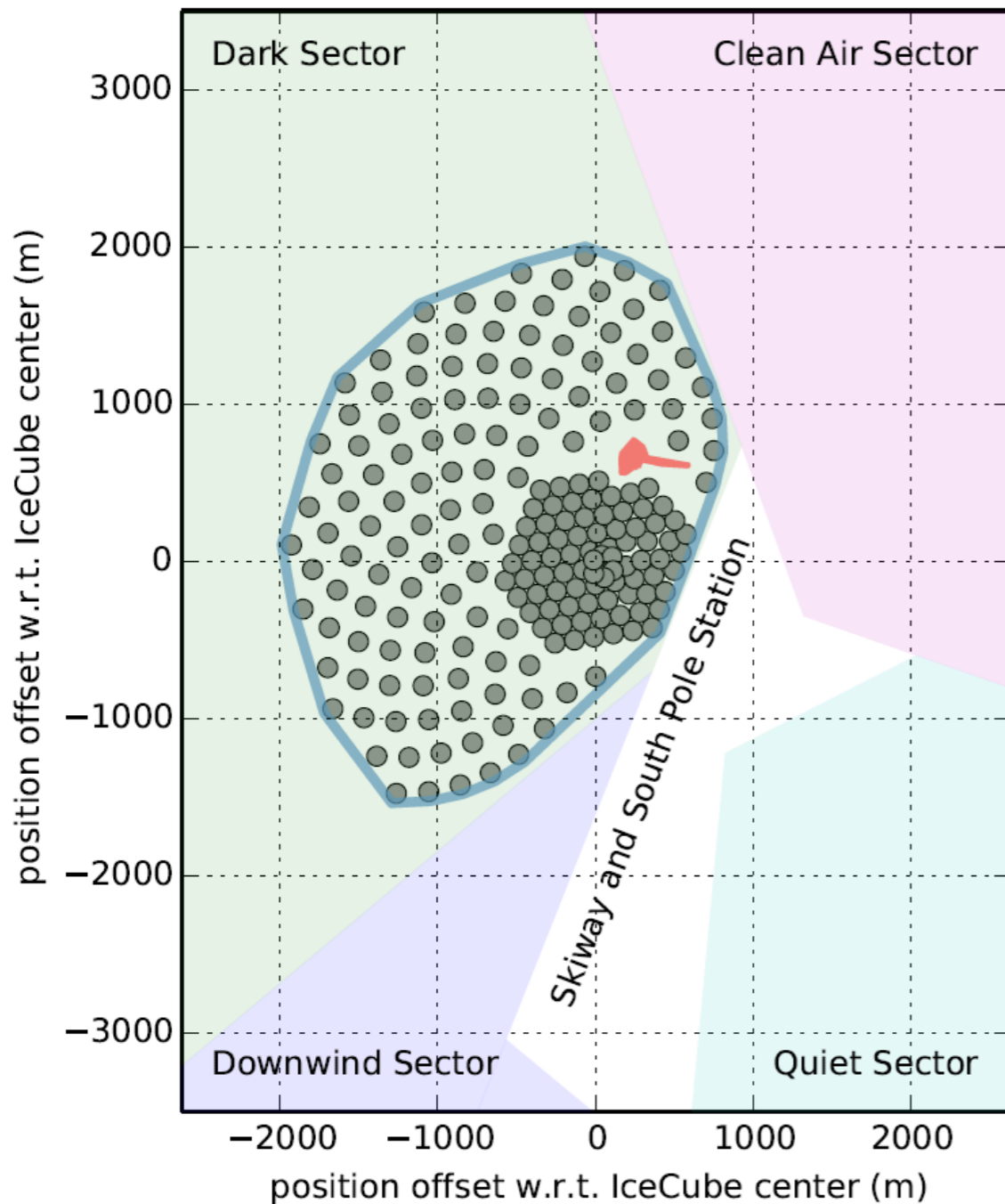

Gen2/HEA Parameters

Strings 120

DOMs / String 80

String Length 1.3 km

Baseline

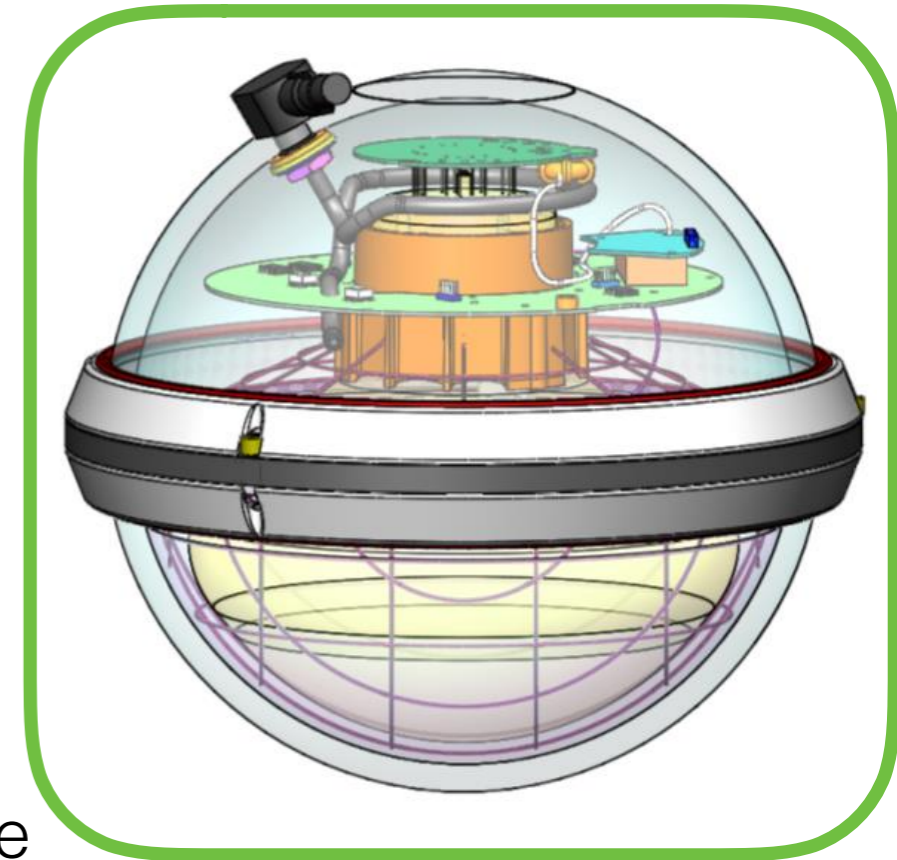

- **Play it safe:** current DOM works pretty well – certainly the lowest risk option would be to make minor tweaks to this design
 - For a fast deployment (i.e. PINGU) this might be the best option
 - Need lots of channels however for HEA
- **Higher risk:** Spend some time and effort on research into improved photo-detection methods – these also will have beneficial impacts for the entire community
 - Maybe not for PINGU, depends on time-scale
 - For Gen2/HEA we probably have some time.
- A few options on the table for better photodetectors:
 - mDOM, WOM, and dual-PMT d-Egg



all results **VERY PRELIMINARY**
(e.g. this is for incoming track
events only right now!)

Predicting observable distributions

Φ_ν

neutrino flux

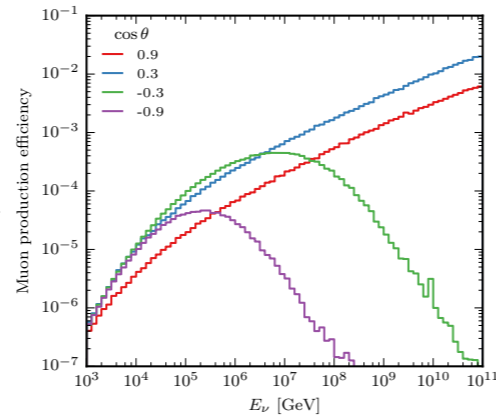

$\nu \rightarrow \mu$ efficiency

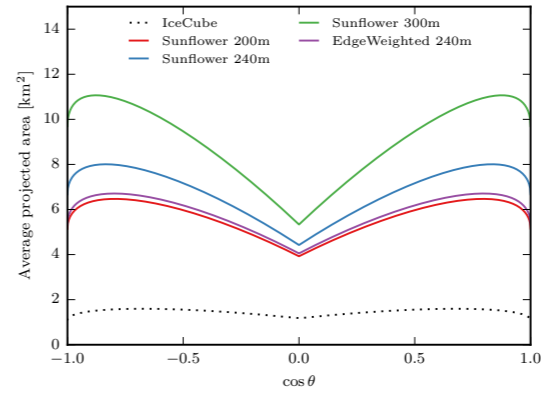

geometric area

selection efficiency

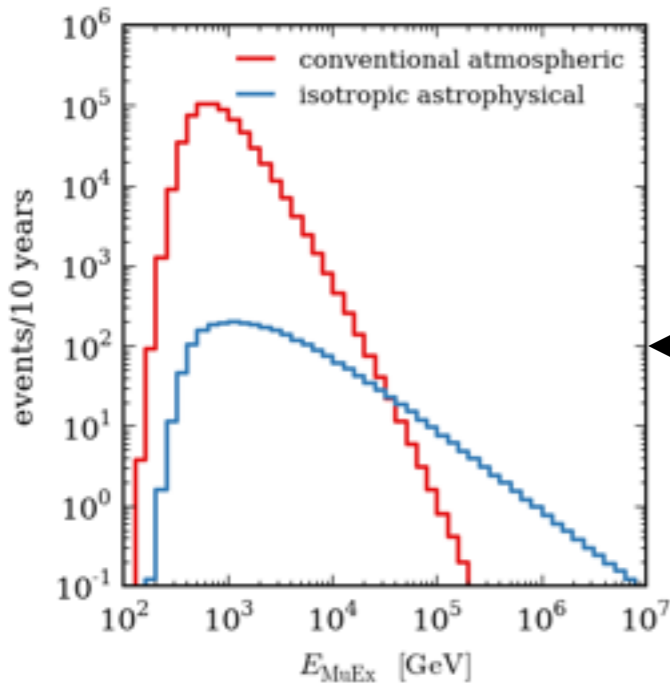
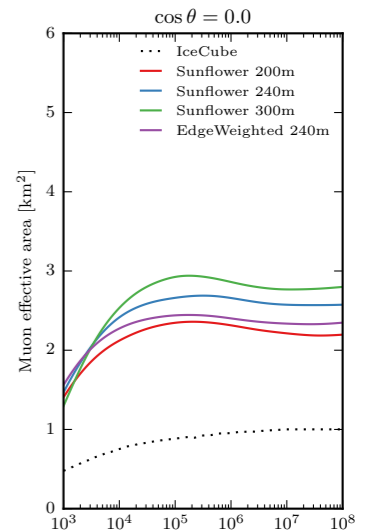

observables

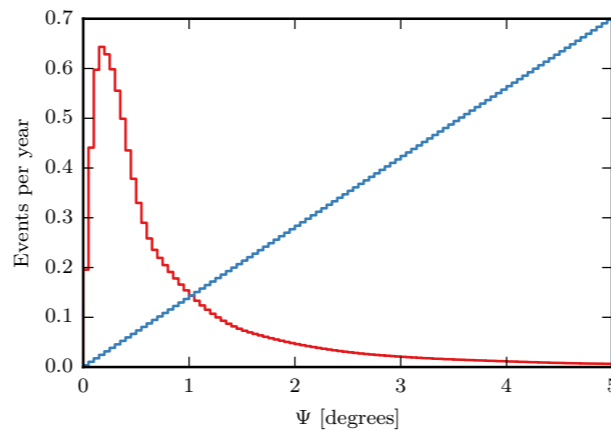

angular resolution

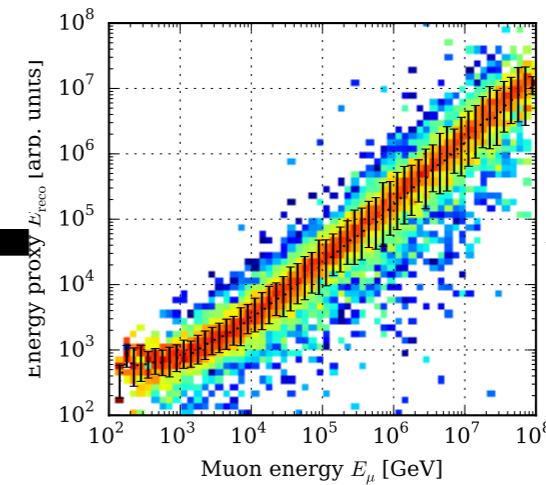

energy resolution

Idealized surface veto model

- ▶ All events from the northern hemisphere are neutrinos
- ▶ Surface veto removes all atmospheric backgrounds above energy threshold and below maximum zenith angle.

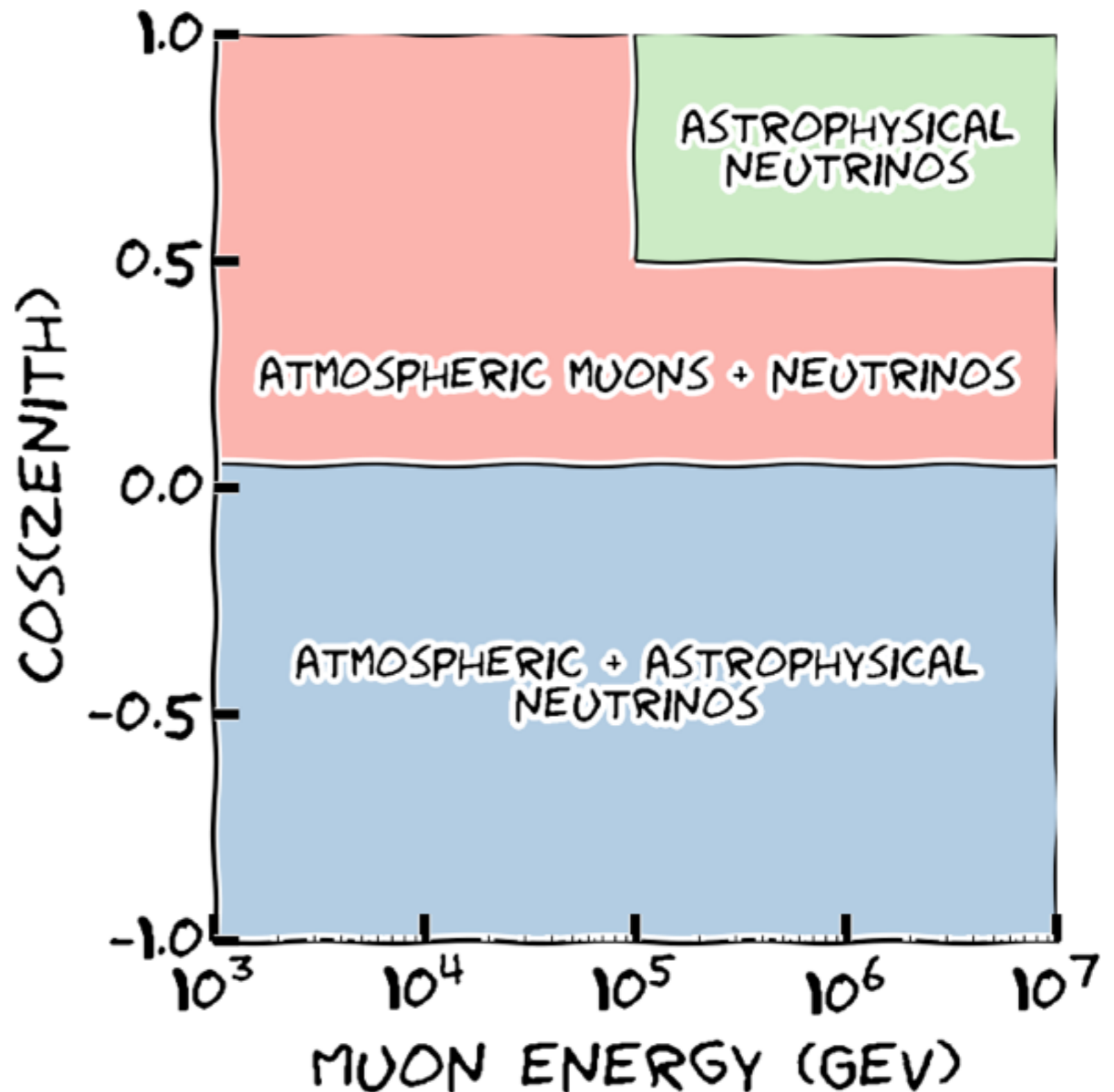

Point Sources with the baseline detector

Point source survey volume = $\Omega \times d^3$ with $d \propto 1/\sqrt{(\text{flux})}$

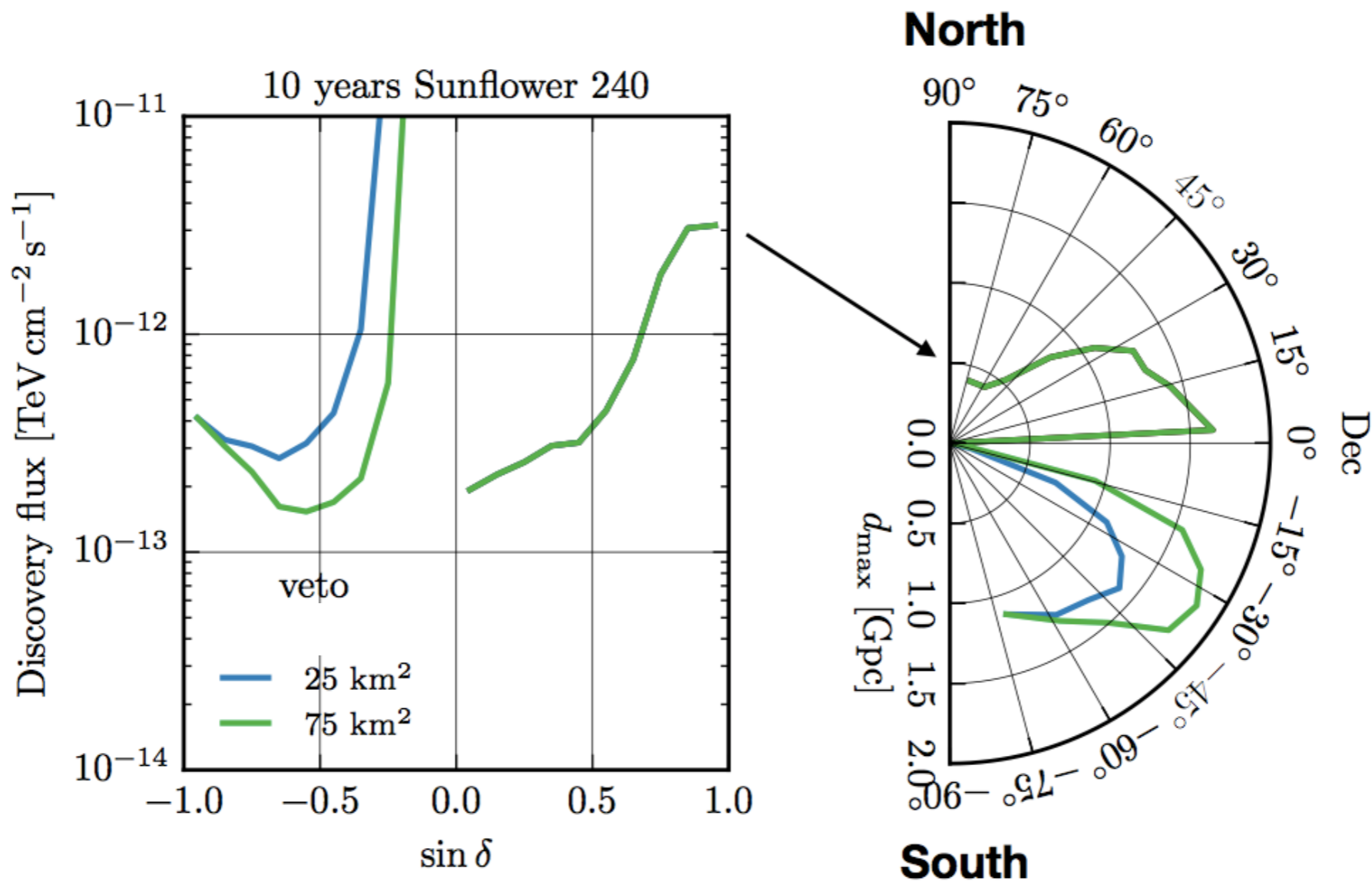

Factor 4.5 improvement in volume!

Gamma Ray Bursts

Modelled by Bustamante et al. Nature Commun. 2015, arXiv:1409.2874v1

Emission nearly independent of GRB parameters, consistent with standard prediction for some parameters

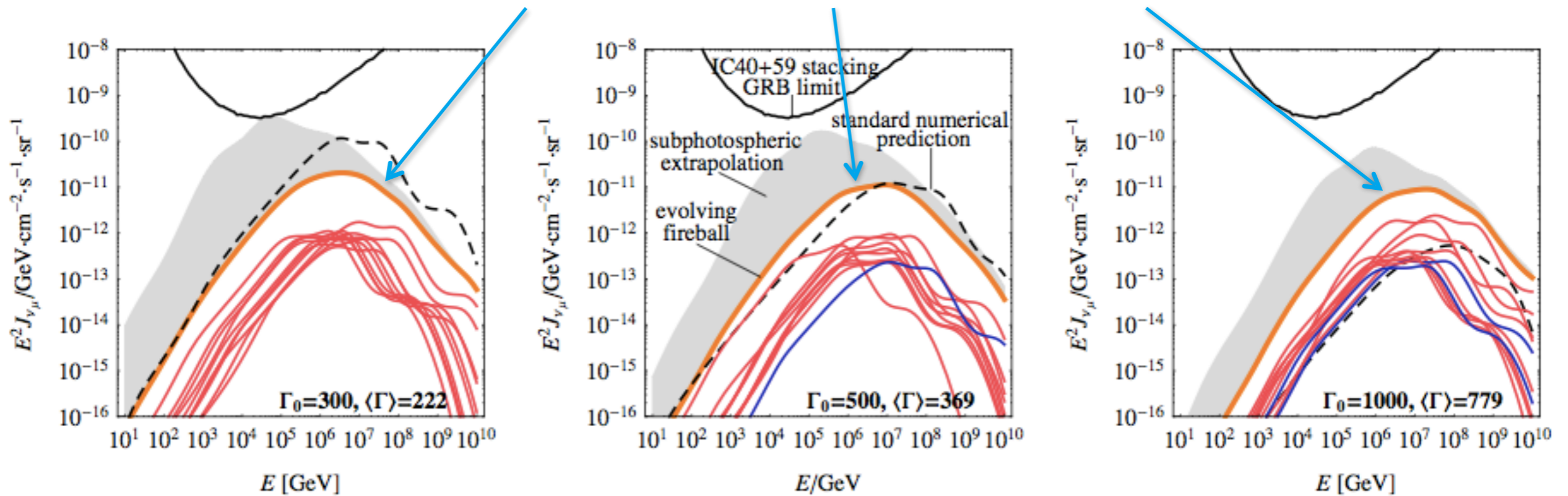

Factor 3.2 improvement in discovery potential

We will be able to see these!

Galactic Diffuse Emission

- Figure of merit: median significance of galactic excess above 10 TeV, 100 TeV
- Backgrounds: atmospheric neutrinos, $E^{-2.3}$ diffuse flux
- Caveats: Does not make full use of angular resolution; contained events will add significance

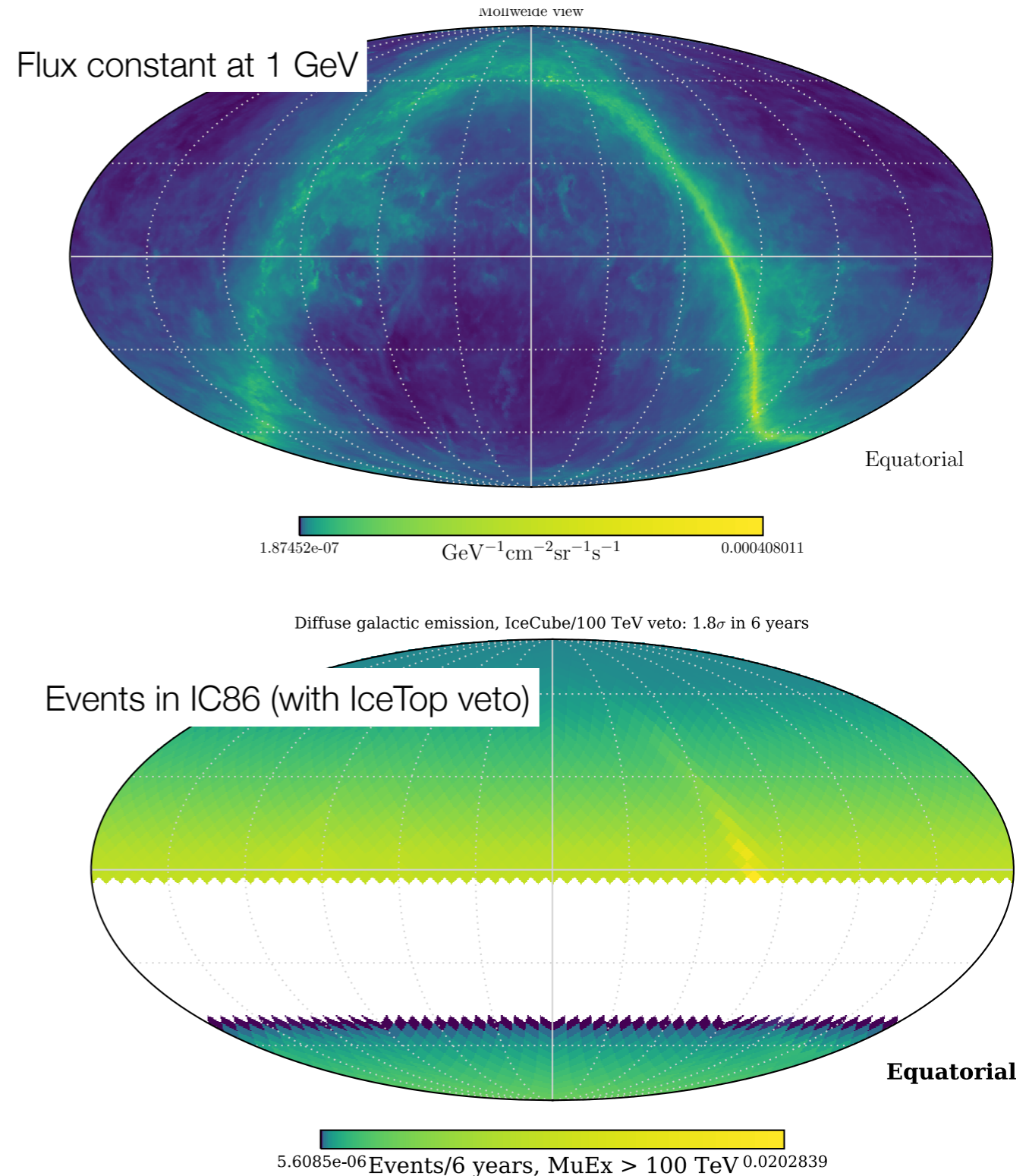

Factor 3.5 better than IC!

GZK Discovery Potential

- Figure of merit: multiple of minimal flux that can be discovered at 5σ in 10 years in 50% of trials
- Backgrounds: atmospheric neutrinos, $E^{-2.3}$ diffuse flux
- Caveat: Assumes that you need a surface veto to look up

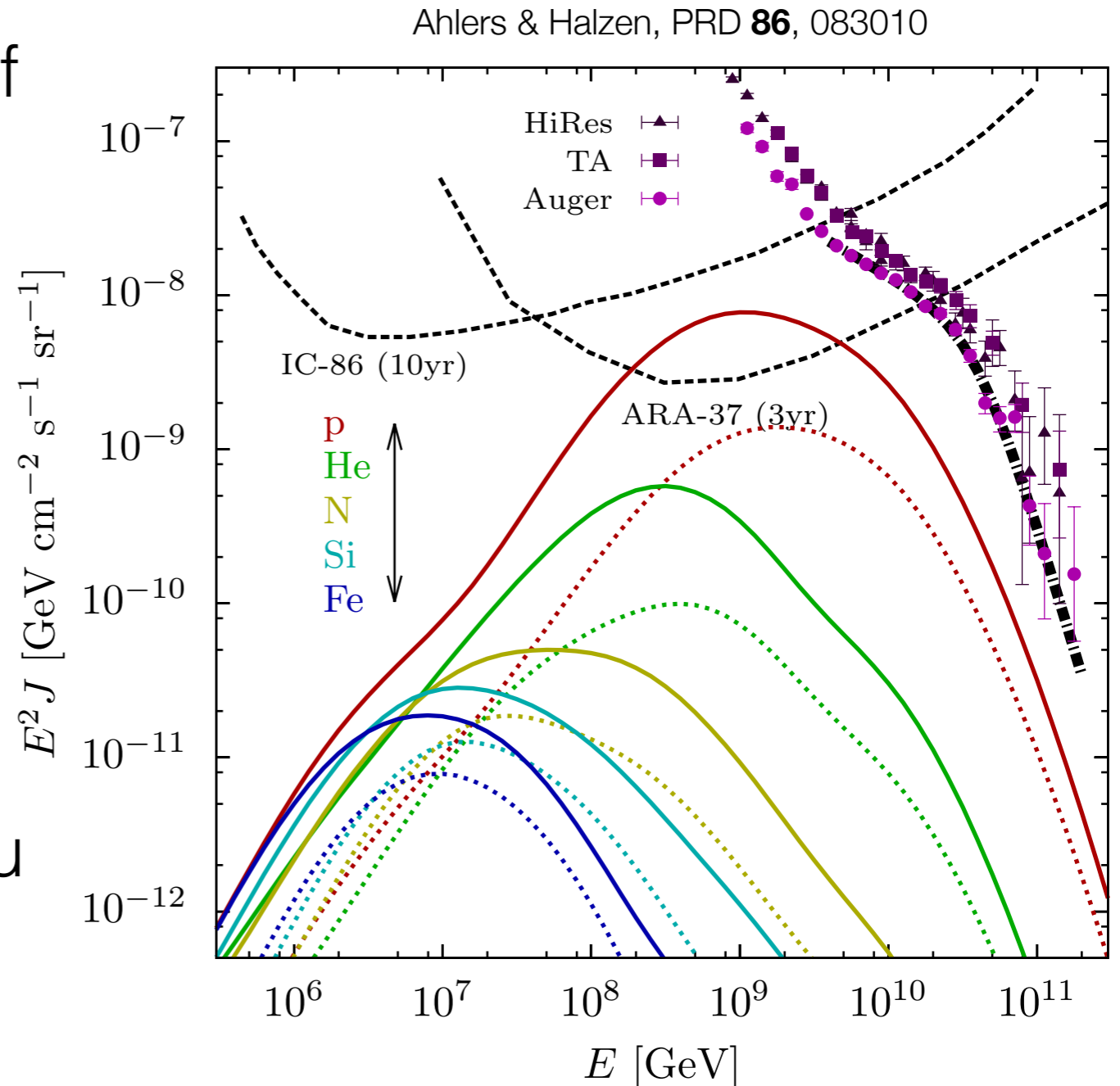

Diffuse Fluxes

- One figure of merit: spectral index resolution σ_γ
- Restrict analysis to muons above 100 TeV, 1 PeV, constraining neutrino spectrum above that energy
- Caveats:
 - Spectral information can also be gleaned from lower-energy muons
 - Contained events will significantly boost resolution

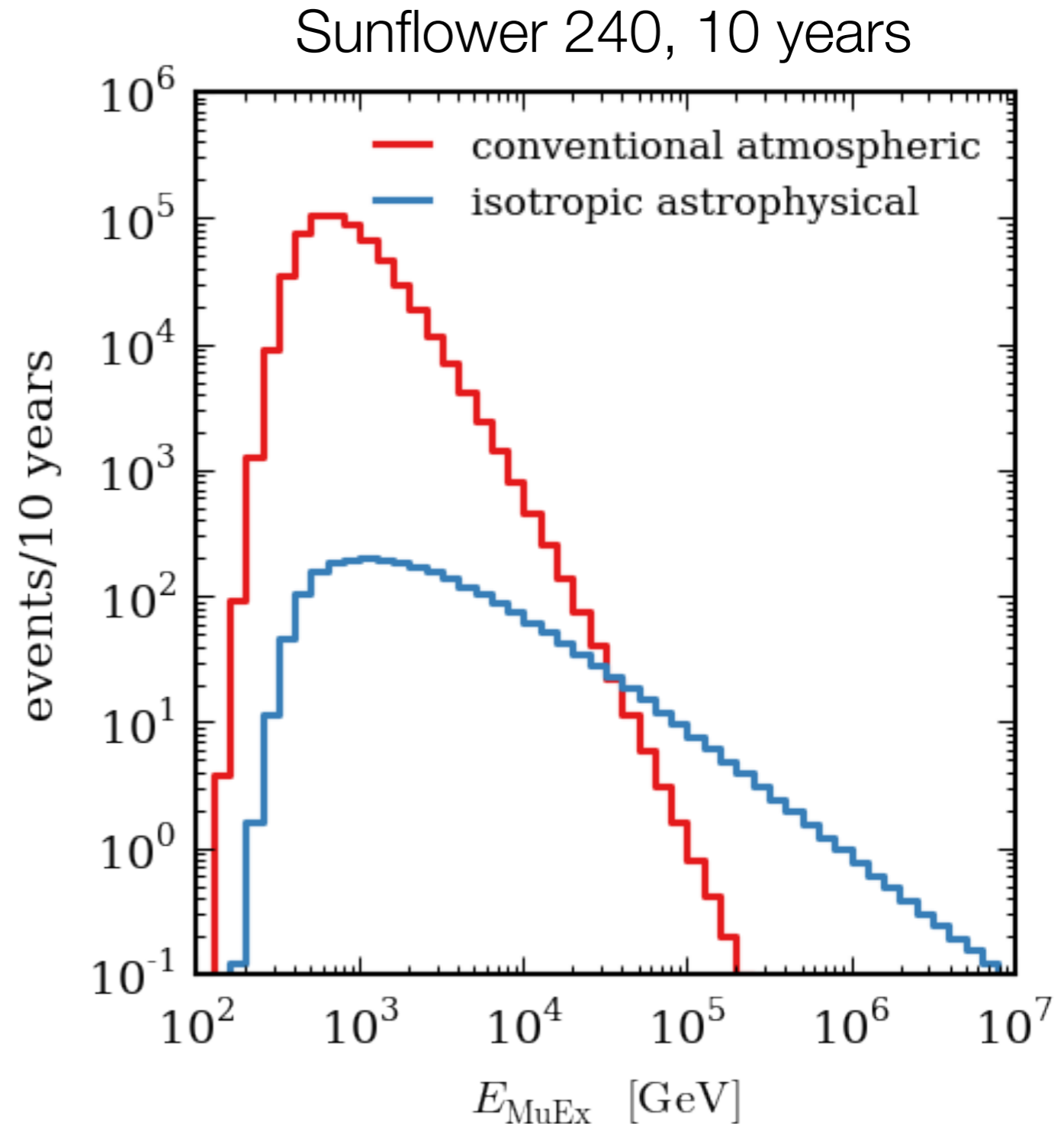

Resolving the Sources of our Diffuse Flux

We need to have an answer for all possible cases

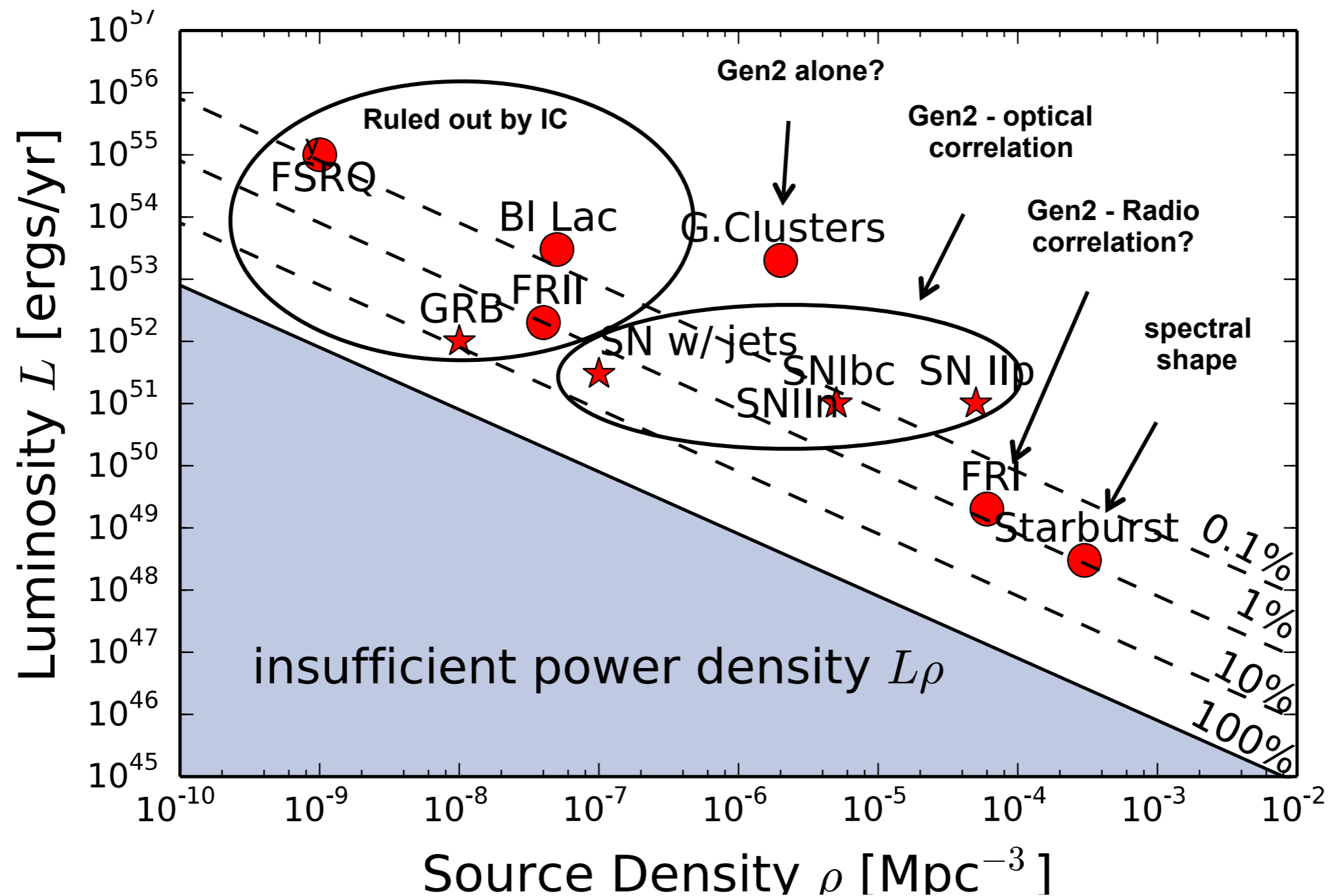

Outlook

$$\text{Gen2/IC} \approx 2 \times (1 + \delta_{\text{geo}}) \times (1 + \delta_{\text{reco}}) \times (1 + \delta_{\text{veto}}) \times (1 + \delta_{\text{tech}})$$

Outlook

$$\text{Gen2/IC} \approx 2 \times (1 + \delta_{\text{geo}}) \times (1 + \delta_{\text{reco}}) \times (1 + \delta_{\text{veto}}) \times (1 + \delta_{\text{tech}})$$

up to 50%
gain from veto!
(see next talk)



Outlook

$$\text{Gen2/IC} \approx 2 \times (1 + \delta_{\text{geo}}) \times (1 + \delta_{\text{reco}}) \times (1 + \delta_{\text{veto}}) \times (1 + \delta_{\text{tech}})$$

up to 30% from optimal geometry?

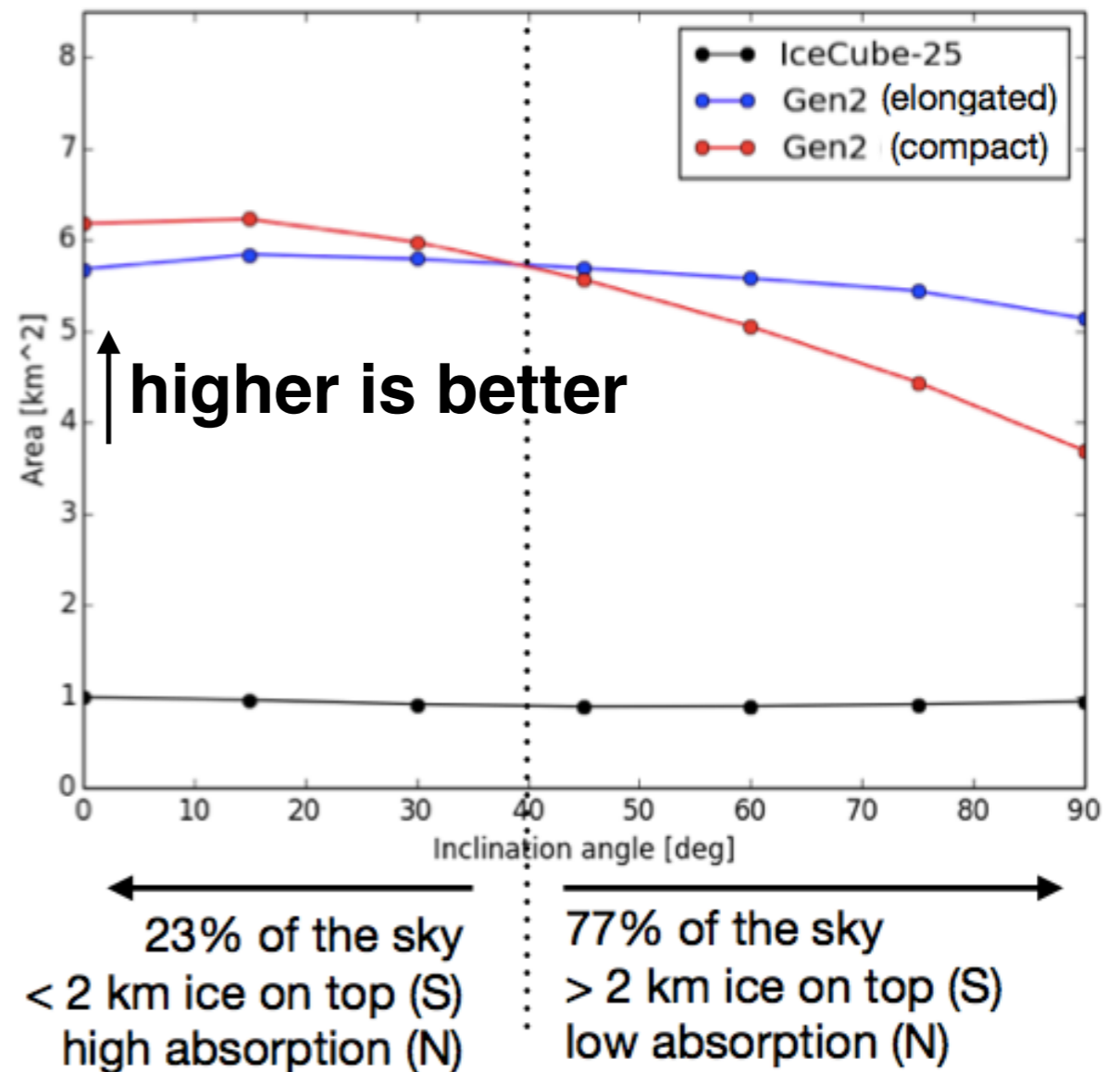

Outlook

$$\text{Gen2/IC} \approx 2 \times (1 + \delta_{\text{geo}}) \times (1 + \delta_{\text{reco}}) \times (1 + \delta_{\text{veto}}) \times (1 + \delta_{\text{tech}})$$

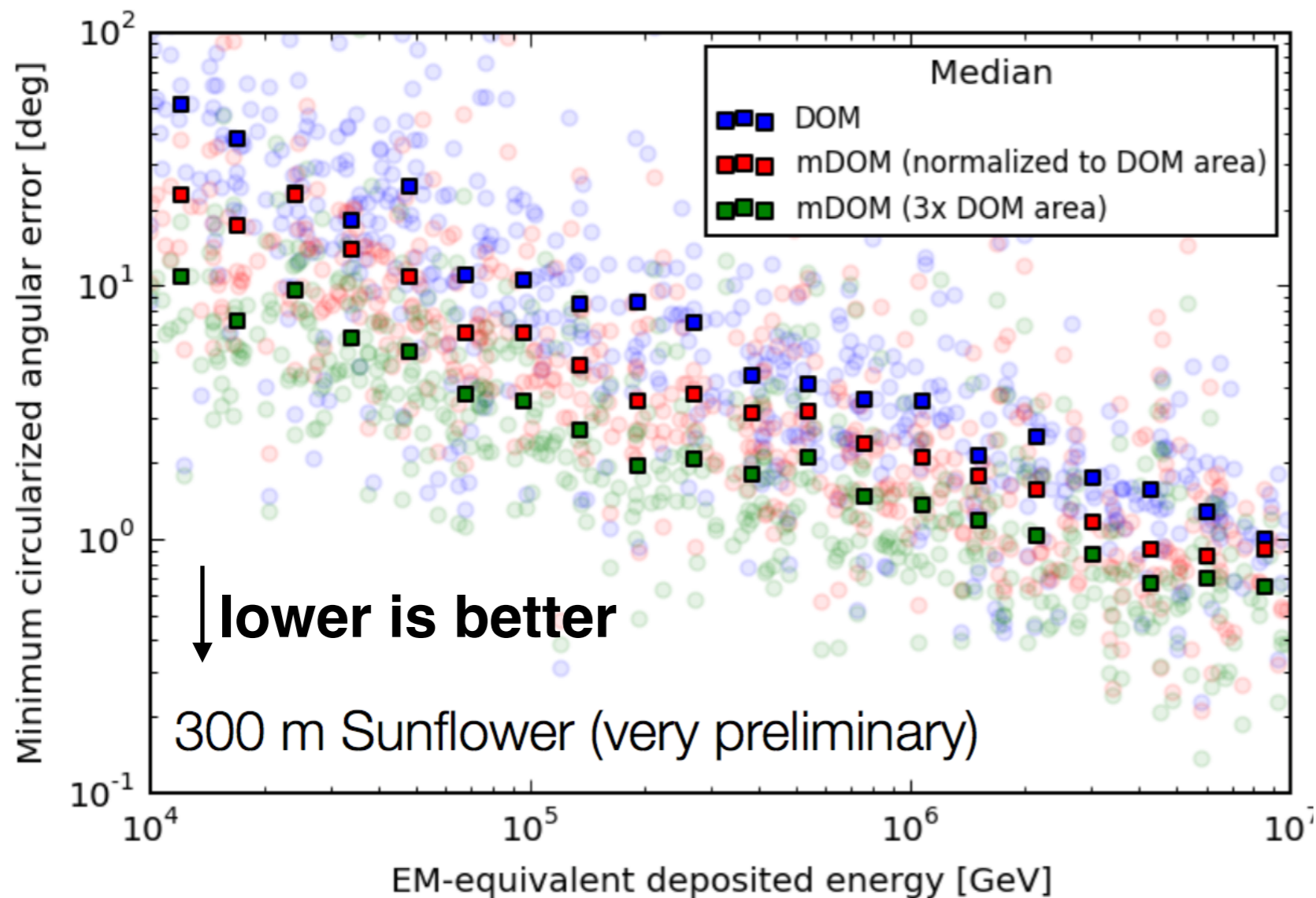

up to 50% gain from better technology?

Outlook

$$\text{Gen2/IC} \approx 2 \times (1 + \delta_{\text{geo}}) \times (1 + \delta_{\text{reco}}) \times (1 + \delta_{\text{veto}}) \times (1 + \delta_{\text{tech}})$$

'WAVEFORMS' OF EACH PMT

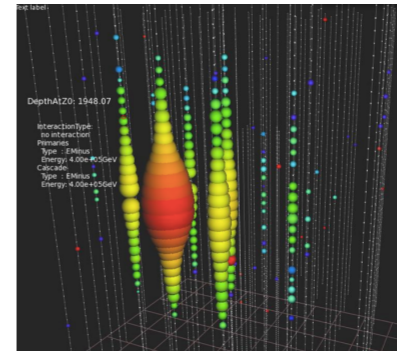

PMT up
PMT down

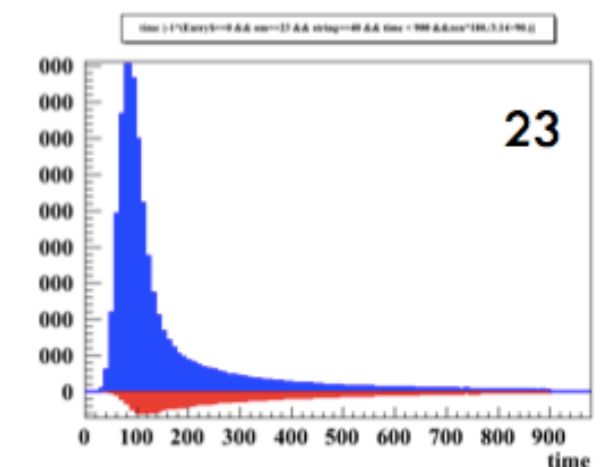
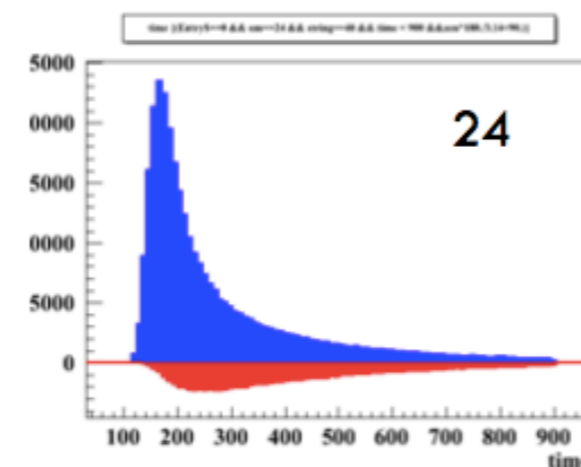
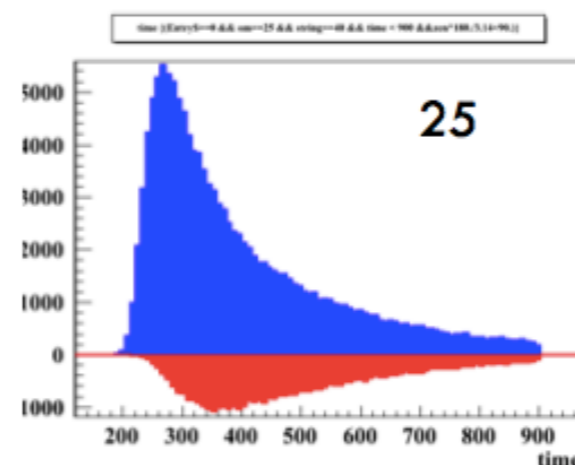
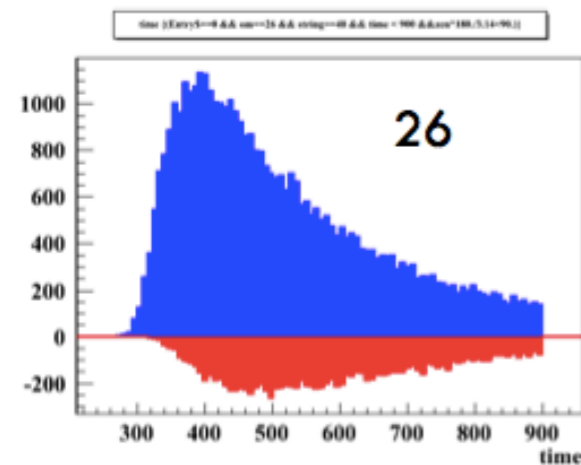
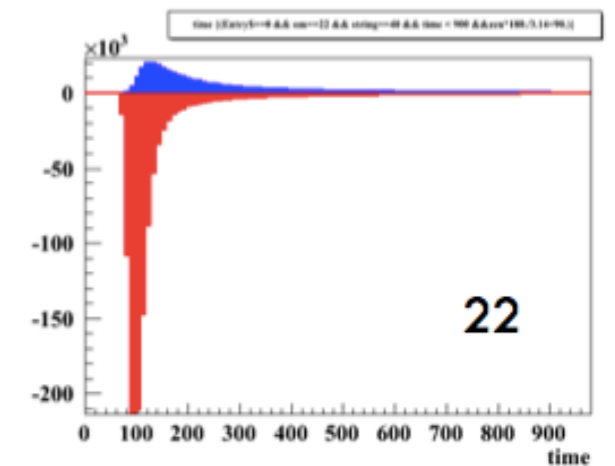
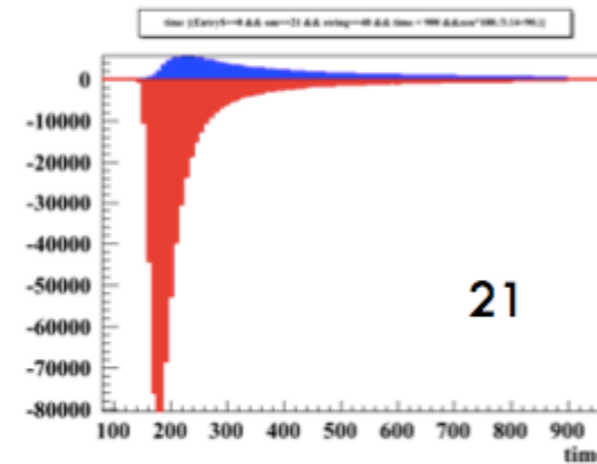
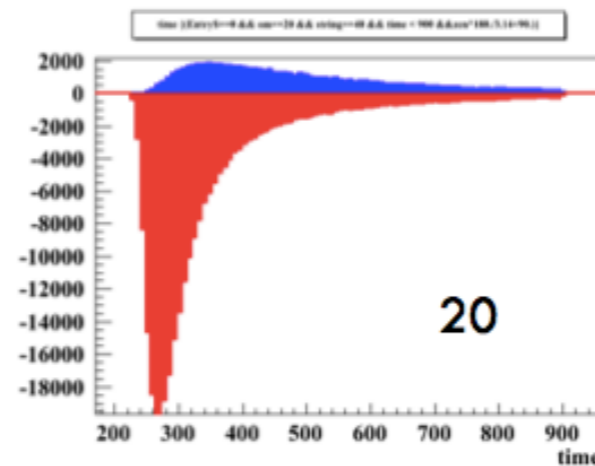
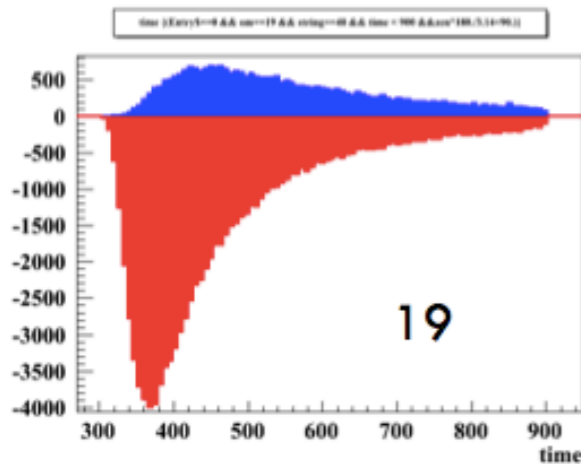

Outlook

$$\text{Gen2/IC} \approx 2 \times (1 + \delta_{\text{geo}}) \times (1 + \delta_{\text{reco}}) \times (1 + \delta_{\text{veto}}) \times (1 + \delta_{\text{tech}})$$

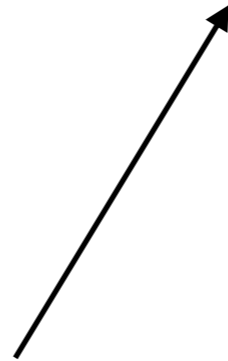

up to 50% from better
reconstruction?

Outlook

$$\text{Gen2/IC} \approx 2 \times (1 + \delta_{\text{geo}}) \times (1 + \delta_{\text{reco}}) \times (1 + \delta_{\text{veto}}) \times (1 + \delta_{\text{tech}}) \approx 8$$

up to 30% from
optimal geometry?



up to 50% from better
reconstruction?

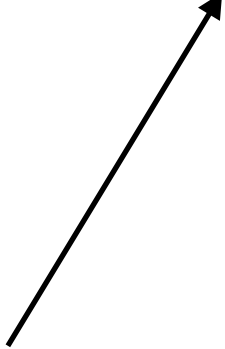

up to 50%
gain from veto!



up to 50% gain from
better technology?



(10 years)

Figures of Merit

very preliminary

Figure of Merit	IC86		In-ice: Sunflower 240			Surface veto: 75km ² /100 TeV		
	no veto	25km ² 100 TeV	no veto	25km ² 100 TeV	75km ² 100 TeV	Sunflower 200m	Sunflower 300m	EdgeWeighted 240m
Survey volume ↑	2.12	3.61	3.60	6.14	9.67	8.92	7.00	10.20
Significance of galactic diffuse emission (>10 TeV) ↑	1.42	1.65	2.59	2.90	3.05	2.80	3.17	2.88
(> 100 TeV) ↑	0.51	0.87	0.93	1.48	1.78	1.66	1.83	1.71
Astrophysical index resolution (>100 TeV) ↓	0.22	0.12	0.16	0.08	0.07	0.07	0.07	0.07
“ (>1 PeV) ↓	0.41	0.30	0.34	0.22	0.18	0.19	0.17	0.19
GRB discovery potential ↓	5.28	3.53	3.01	2.10	1.64	1.77	1.93	1.63
GZK discovery potential ↓	25.83	9.66	14.05	4.78	3.49	3.79	3.10	3.76

baseline

Summary

- We have identified a baseline detector (includes a veto)
- Working out the detailed science case
- Meanwhile we have time to improve, including new sensor technology and components
- We are preparing conceptual design documentation

Backup

In-ice detector

Sunflower

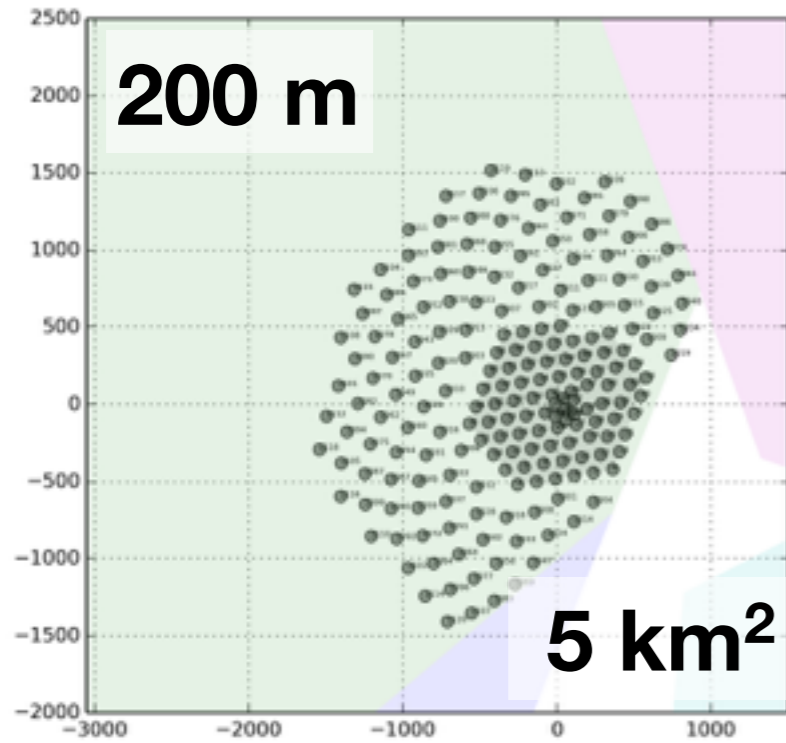

- ▶ **122-125 strings**
- ▶ **80 DOMs per string**

Edge-weighted

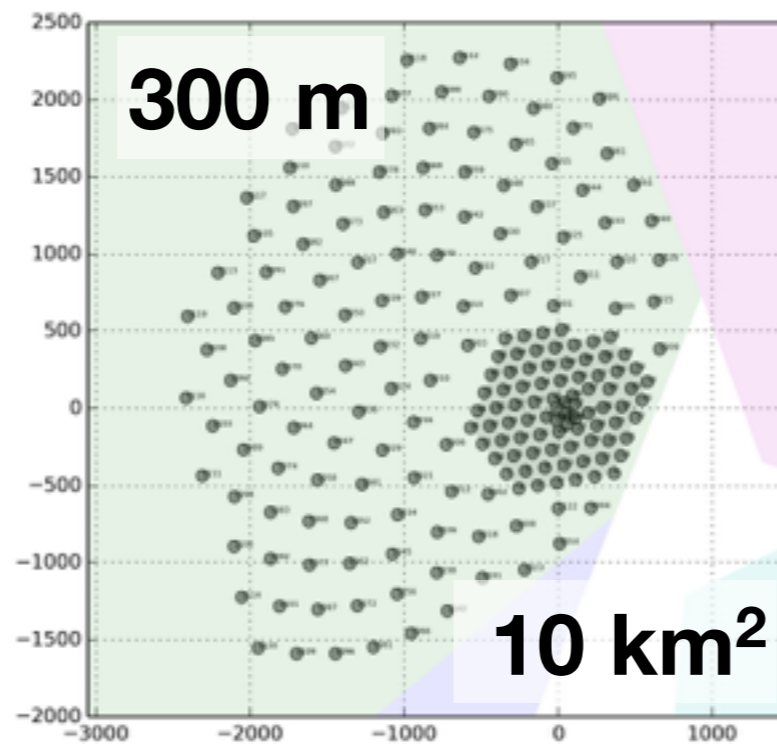
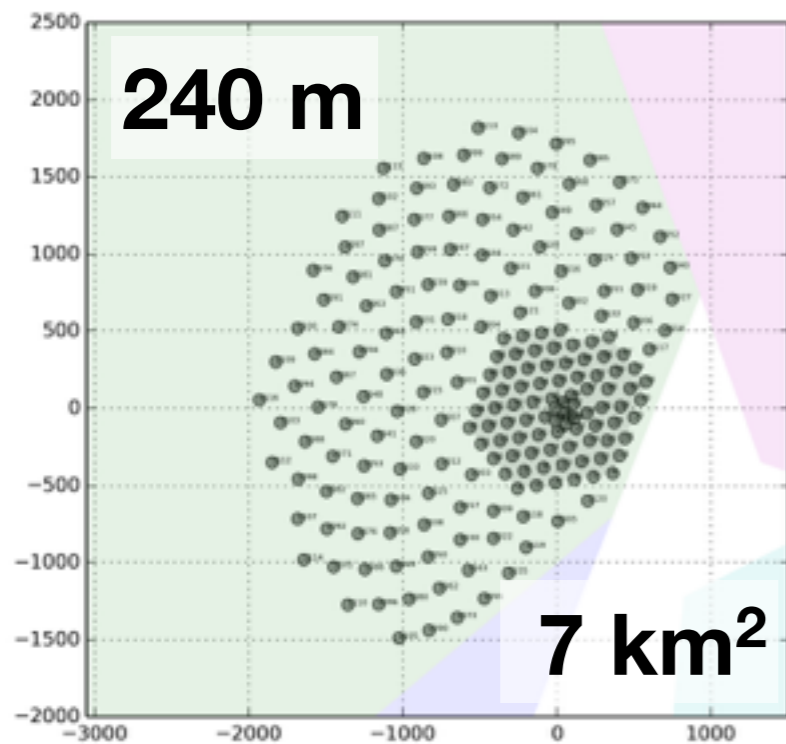
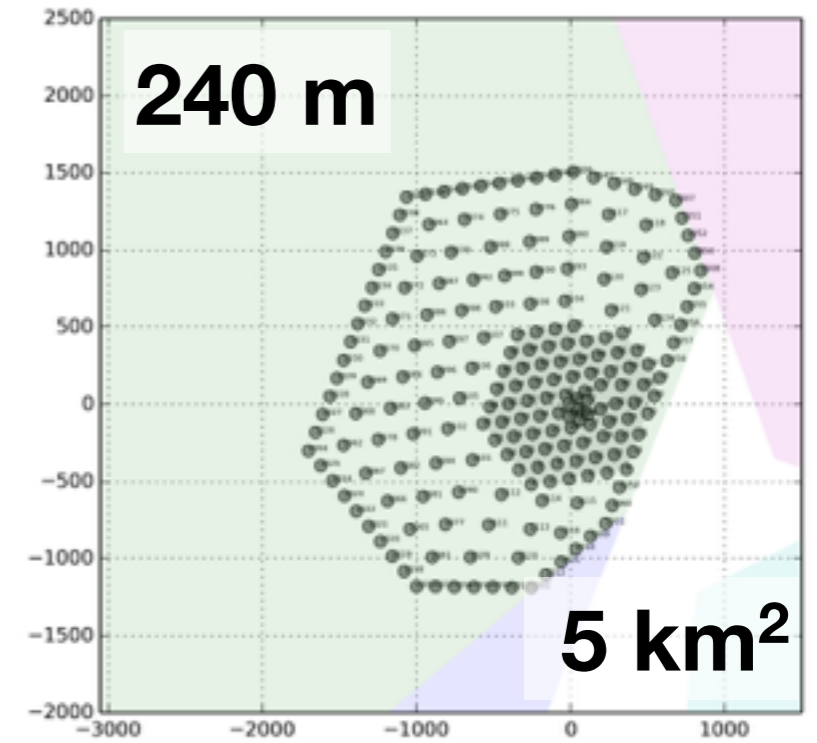

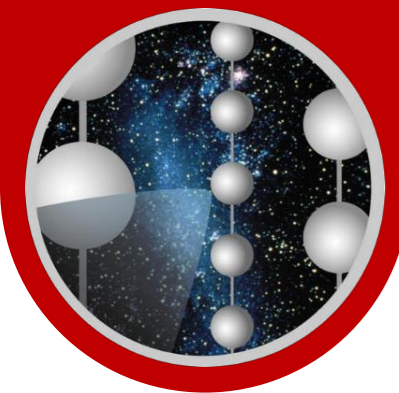

ICECUBE-GEN2
COLLABORATION

A multi-PMT optical module for IceCube-Gen2

Features

- ▶ 24× 3" PMTs (Hamamatsu 12199-02)
- ▶ 14" borosilicate glass pressure vessel rated @ 700 bar (Nautilus)
- ▶ Based on proven KM3NeT design
- ▶ Prototype to be tested in PINGU

Advantages

- ▶ Uniform 4π acceptance
- ▶ 2 times effective area of IceCube DOM @ similar price per photocathode area
- ▶ Directional sensitivity
- ▶ Local coincidences for e.g. background suppression
- ▶ Improved TTS ($\sigma = 1.7$ ns)
(important for leading-edge timing precision)

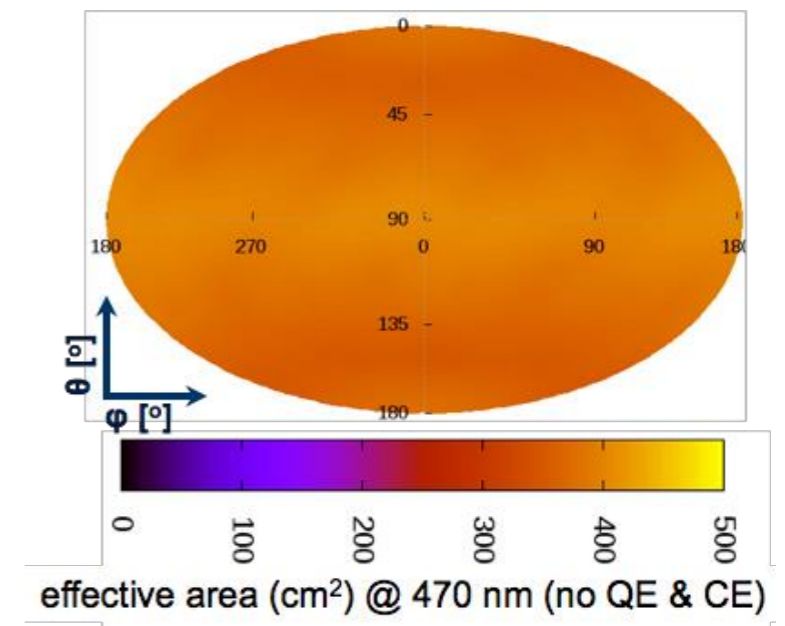

See A. Kappes talk, this conference, for more information.

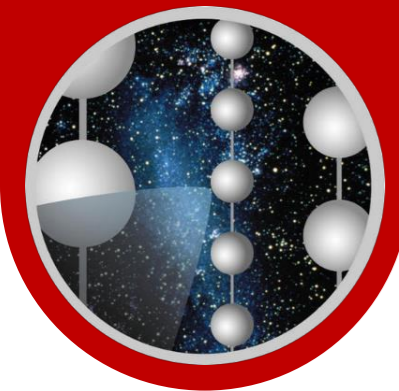

The D-Egg Dual 8" PMT + Improved Glass

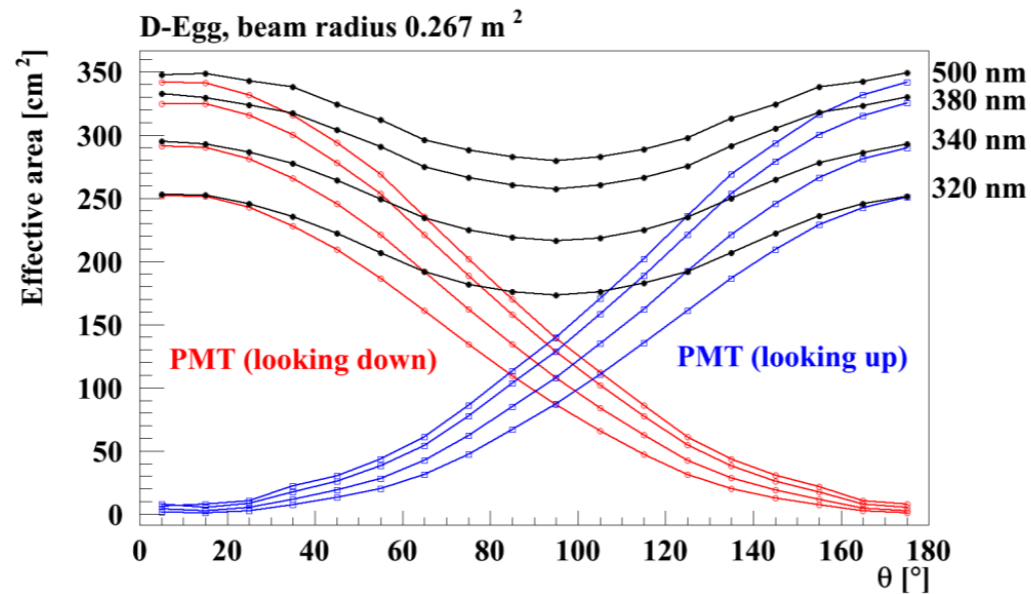

D-Egg uses 2x 8" PMTs. Naively, one would expect only about 30% enhancement in the photon effective area, however, better collection efficiency relative to 10" PMT and massive improvements in UV transparency of glass.

My personal comments:

Whether or not we decide to use 2x 8" or 1x 10" PMT, the gains in UV photon collection from better glasses is well worth the research effort and should be a priority of the photodetection R&D.

Two PMTs could probably still be readout separately with new DOM mainboards equipped with two ADC channels. TODO: investigate whether individual UP/DOWN tube hits give increase in performance versus simple ganged readout.

Wavelength-Shifting Optical Module (WOM)



Idea: light concentration with wavelength shifting light guides

Features

- large collection area
- low noise rate (few Hz)
- better UV sensitivity
- cost effective

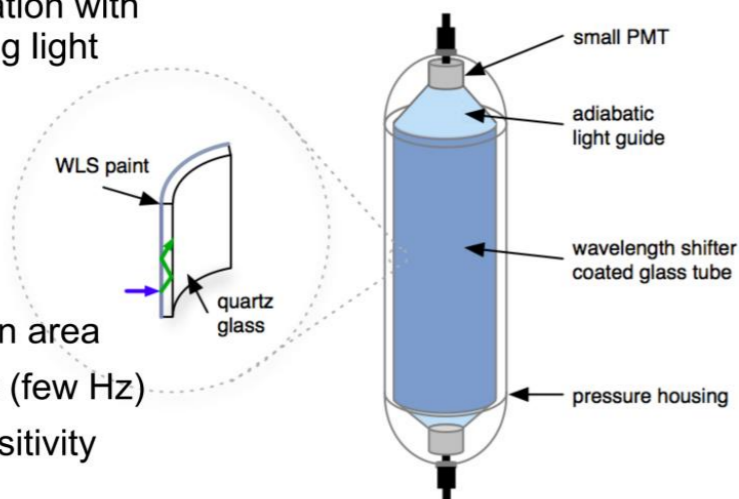

- Wavelength shifter painted on long cylindrical tube.
- Two small 1-2" PMTs at each end
- Time precision, if it does turn out to be worse than IceCube's (< 5 ns) is a critical parameter for PINGU but not a critical parameter for HEA.
- WOM has potential to dramatically increase effective photo collector area.
- Still in early stages of development.



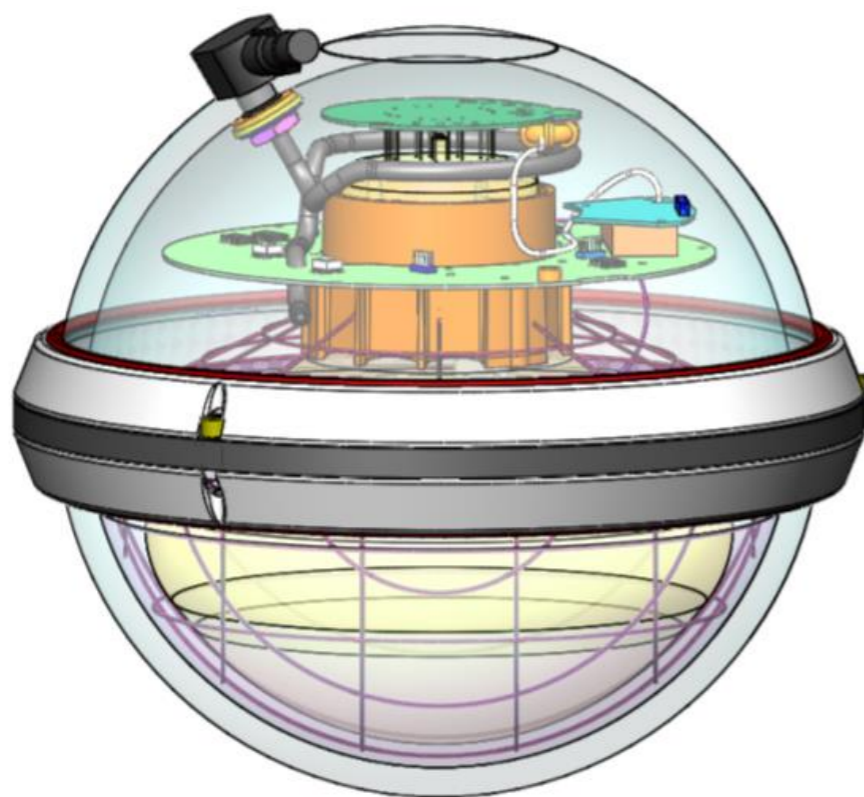
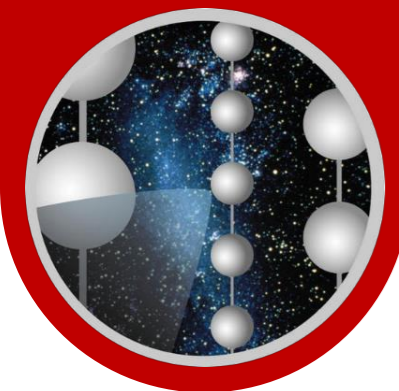

To Improve

- Replace transient waveform capture ASIC with modern pipelined 14-bit 250 MSPS ADC:
 - Eliminates need to pre-trigger ASIC (72 ns delay board)
 - Unify 3 disparate gain channels to single channel – tricky calibration in IceCube
 - Permit capture of arbitrarily long waveforms (currently limited to ~500 ns)
- Update FPGA to modern process, high-density (Cyclone V)
- Replace HV module (good performance but 25% efficiency)

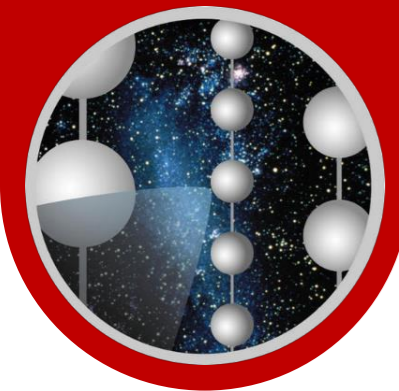

ICECUBE-GEN2
COLLABORATION

Gen2 DOM Electronics

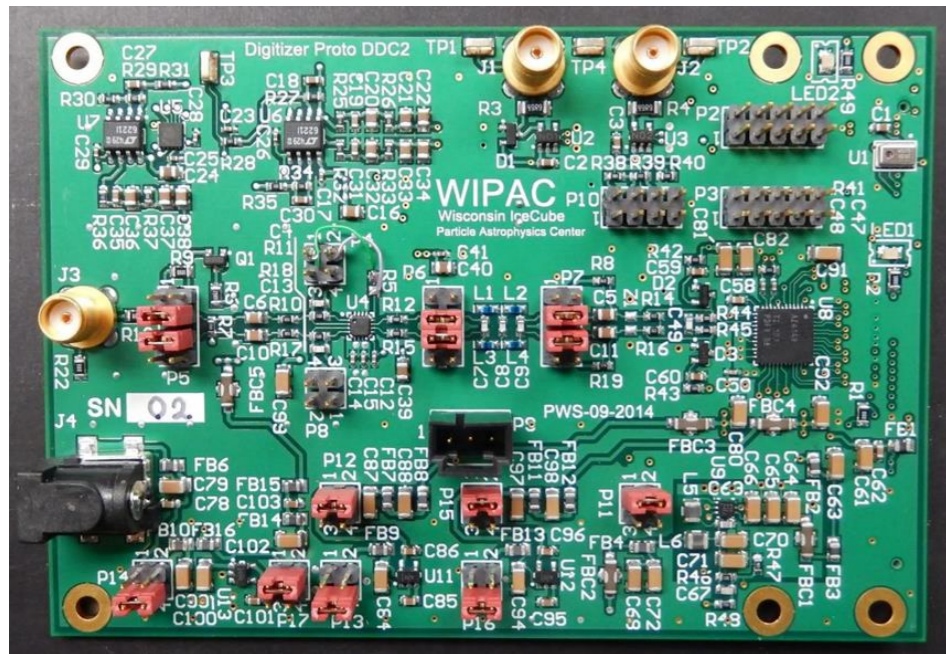

Analog/digital front end boards fabbed 2015Q1 – good performance – 250 MSPS 14-bit, < 300 mW. Noise at 2 LSB. Plug-in via HSMC to standard FPGA development board.

P. Sandstrom - WIPAC

17.10.2015

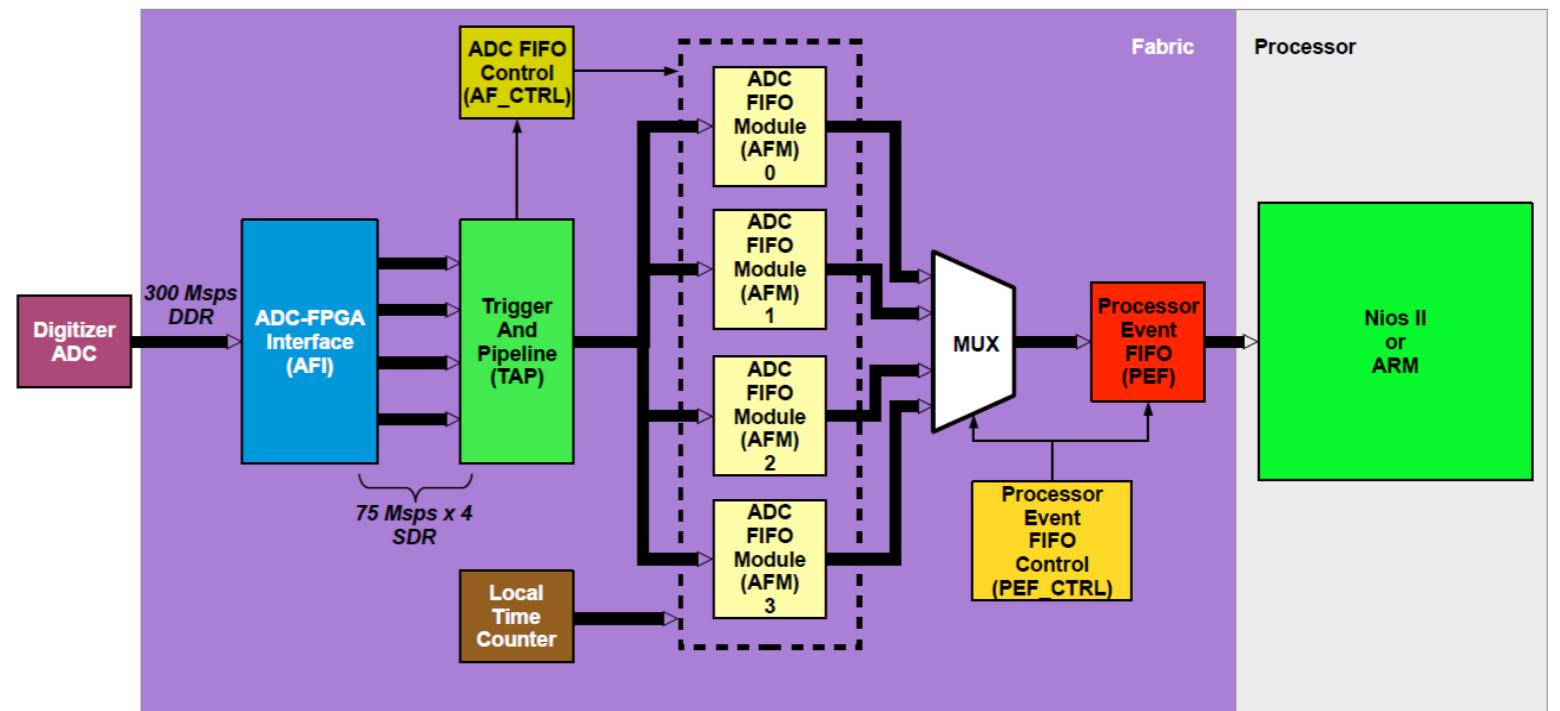

Early prototype firmware with advanced features: full throughput at 250 MSPS (quad pipeline) and control via soft core Nios on Cyclone V FPGA.

T. Anderson – Penn State

Rev0 Gen2 mainboard release planned for 2016Q1

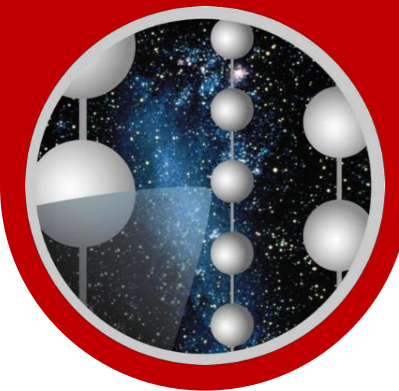

- Communications for large-scale array differ from IceCube. 3.5 km is approx. max distance → fiber out to holes (infinite BW). Downhole cables are then conceptually very similar to IceCube cables – actually shorter.
- Ericsson out of cable business. However copper cable division passed to Hexatronic – MSU working with them on Gen2 cables.
- Rev0 comms card (analog to IceCube DOR) is fabbed – in test (KH Sulanke – DESY)

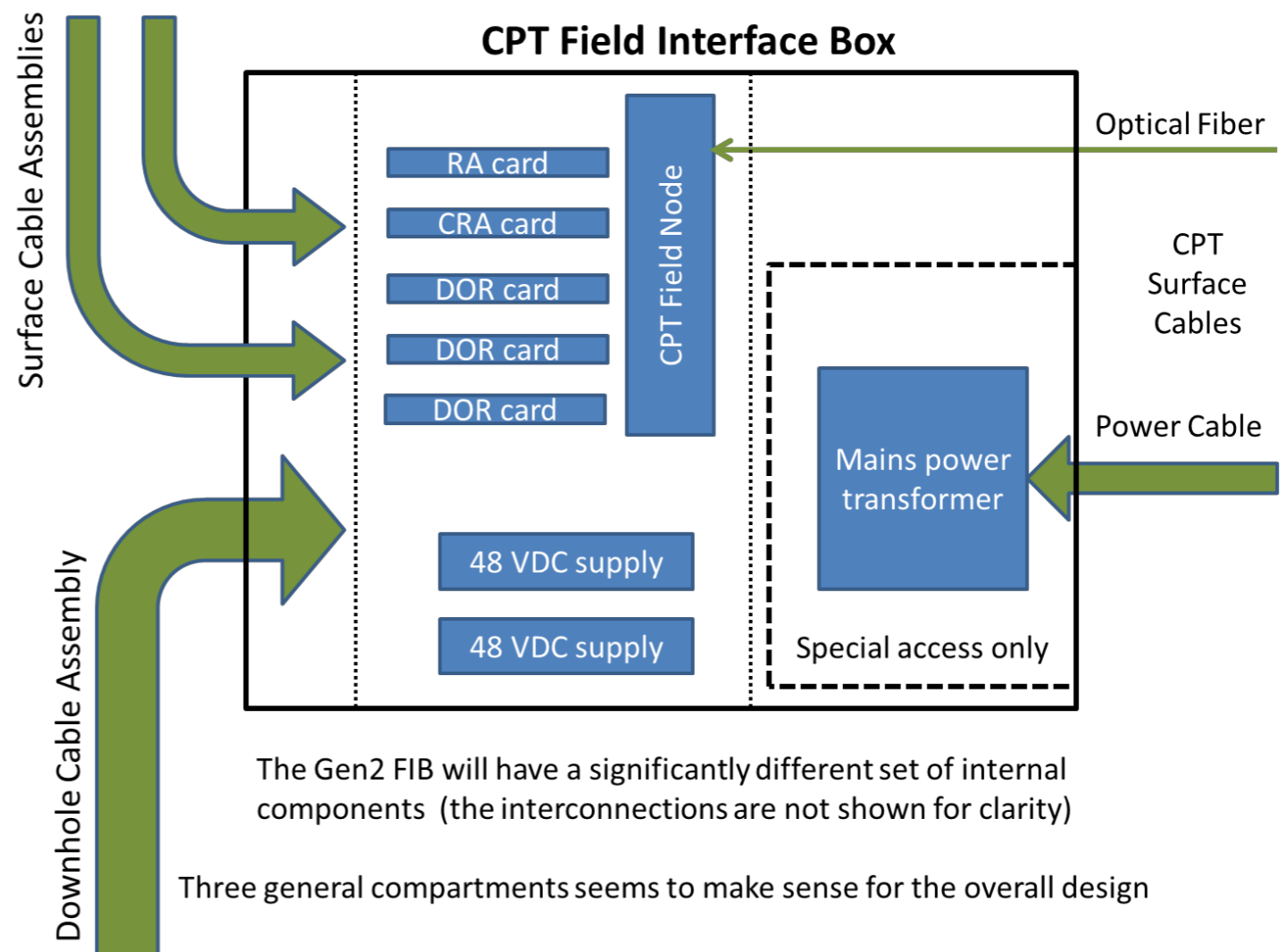

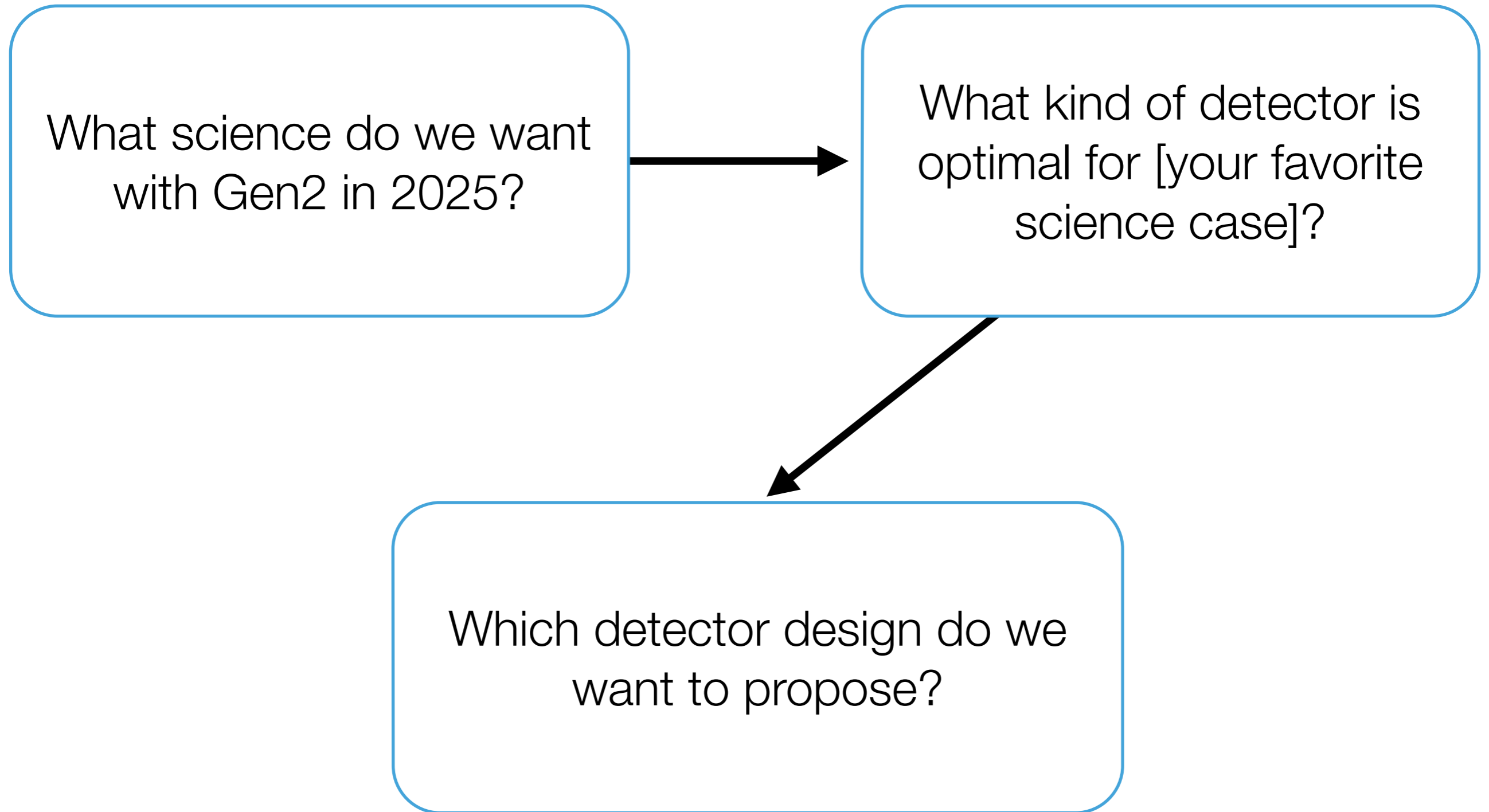

Signal events

Figure of Merit	IC86		In-ice: Sunflower 240			Surface veto: 75km ² /100 TeV		
	no veto	25km ² 100 TeV	no veto	25km ² 100 TeV	75km ² 100 TeV	Sunflower 200m	Sunflower 300m	EdgeWeighted 240m
Survey volume								
Significance of galactic diffuse emission (>10 TeV)	49.00	51.30	163.30	169.20	172.90	142.50	188.40	149.00
(> 100 TeV)	2.80	5.20	8.90	14.80	18.50	15.70	19.70	16.70
Astrophysical index resolution (>100 TeV)	54.20	85.70	171.00	253.00	315.10	264.60	340.50	280.40
“ (>1 PeV)	4.00	9.00	11.30	24.90	34.60	29.40	37.30	31.70
GRB discovery potential	2.20	1.70	3.30	2.50	2.10	2.00	2.40	2.10
GZK discovery potential	5.30	6.80	6.30	9.20	10.60	10.10	11.00	10.50

Background events

Figure of Merit	IC86		In-ice: Sunflower 240			Surface veto: 75km ² /100 TeV		
	no veto	25km ² 100 TeV	no veto	25km ² 100 TeV	75km ² 100 TeV	Sunflower 200m	Sunflower 300m	EdgeWeight ed240m
Survey volume								
Significance of galactic diffuse emission (>10 TeV)	3,646.00	3,678.20	12,181.40	12,265.30	12,329.20	10,341.00	13,444.20	10,879.60
(> 100 TeV)	88.10	120.40	276.40	360.30	424.10	355.80	461.00	375.40
Astrophysical index resolution (>100 TeV)	20.30	20.30	64.70	64.70	64.70	52.70	72.00	54.90
“ (>1 PeV)	0.10	0.10	0.10	0.10	0.10	0.10	0.20	0.10
GRB discovery potential	2.40	2.40	11.30	11.30	11.30	11.30	10.80	12.70
GZK discovery potential	0.70	2.10	1.20	4.10	6.10	5.50	6.20	6.30

Neutrino detection channels

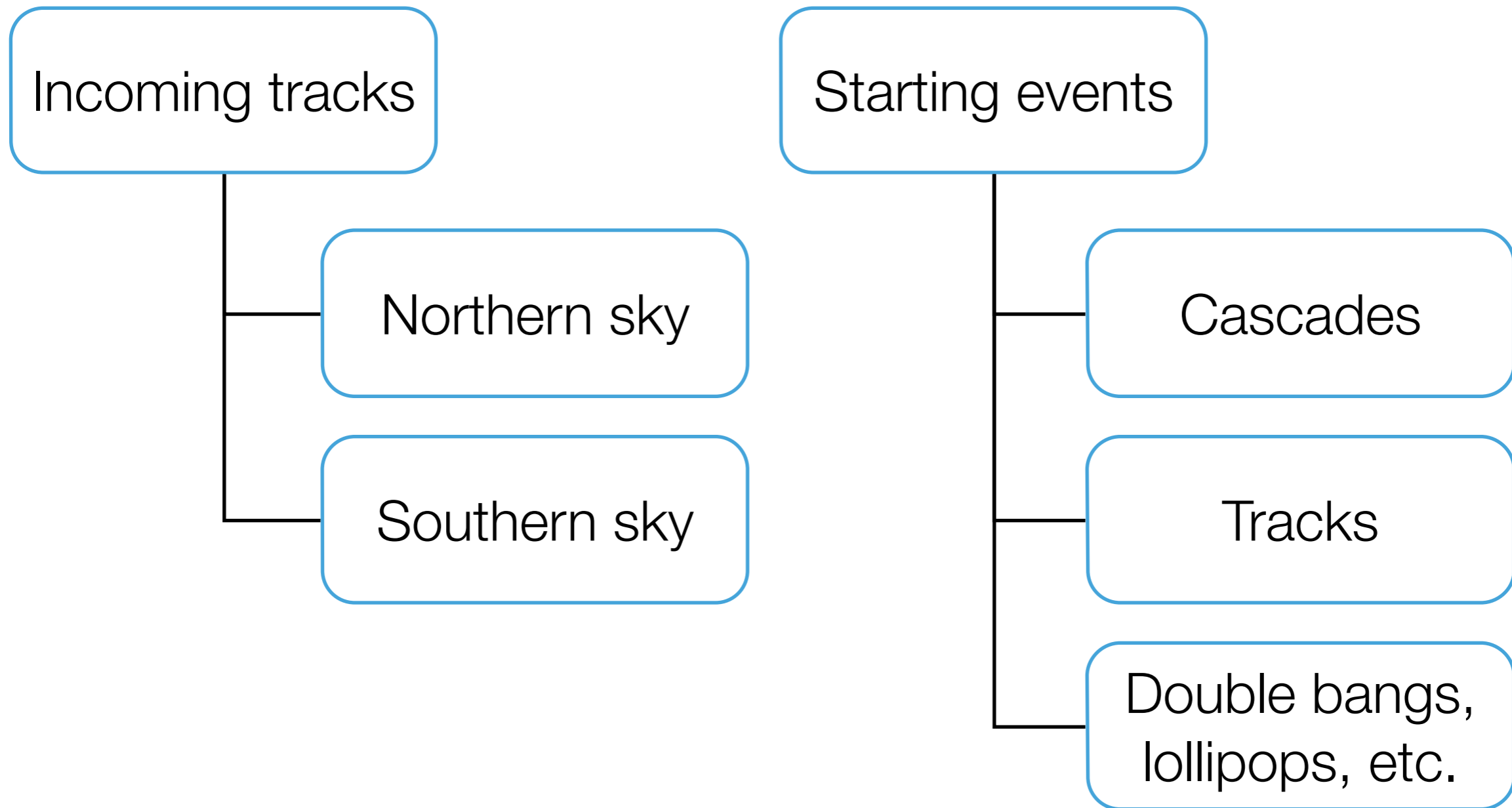

The characteristic effective areas and resolutions for each channel behave differently for various detector geometries.

Figures of merit

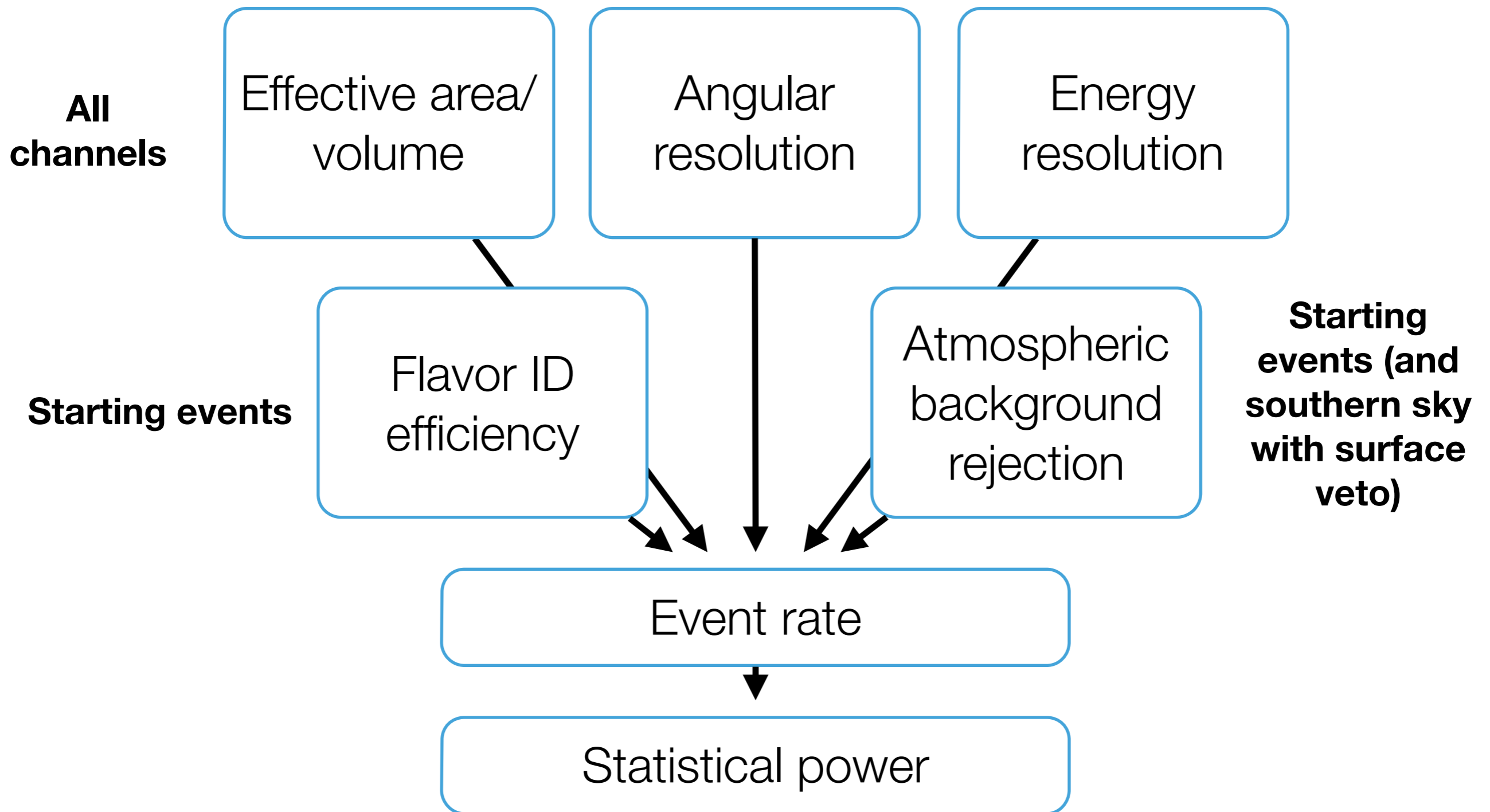

Example: steady point sources

Search: steady point source in the northern sky, using incoming tracks

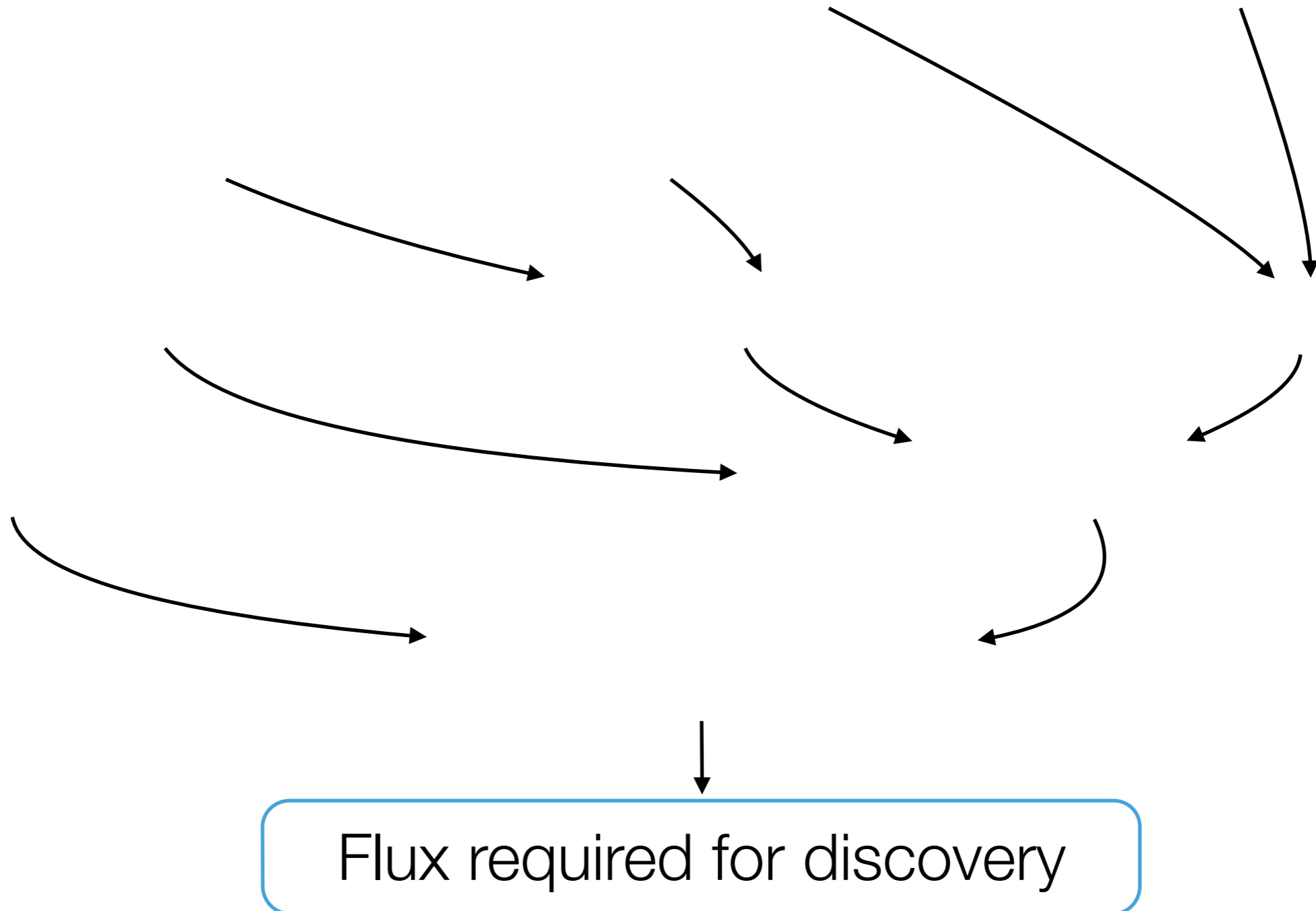

Example: steady point sources

Search: steady point source in the northern sky, using incoming tracks

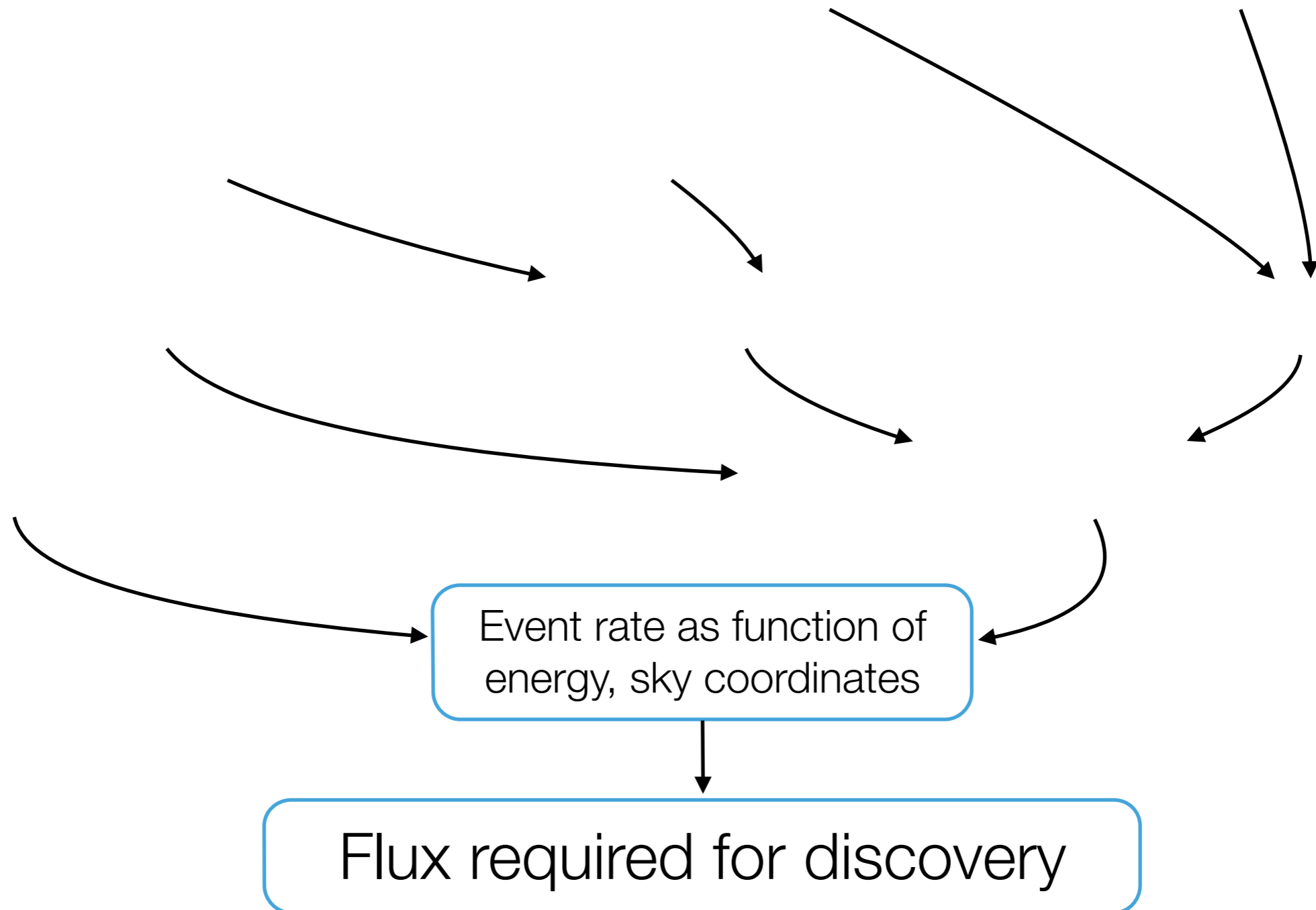

Example: steady point sources

Search: steady point source in the northern sky, using incoming tracks

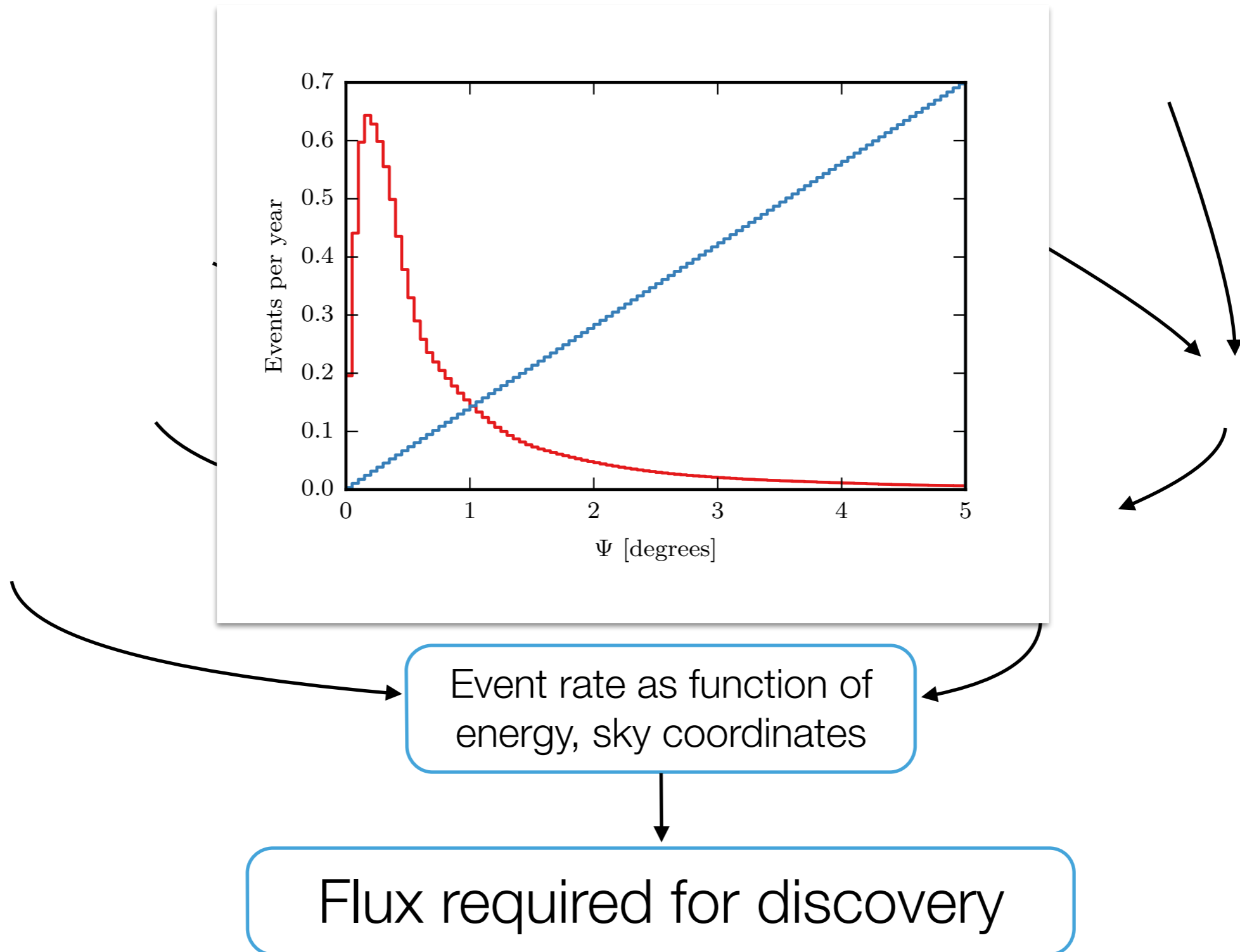

Example: steady point sources

Search: steady point source in the northern sky, using incoming tracks

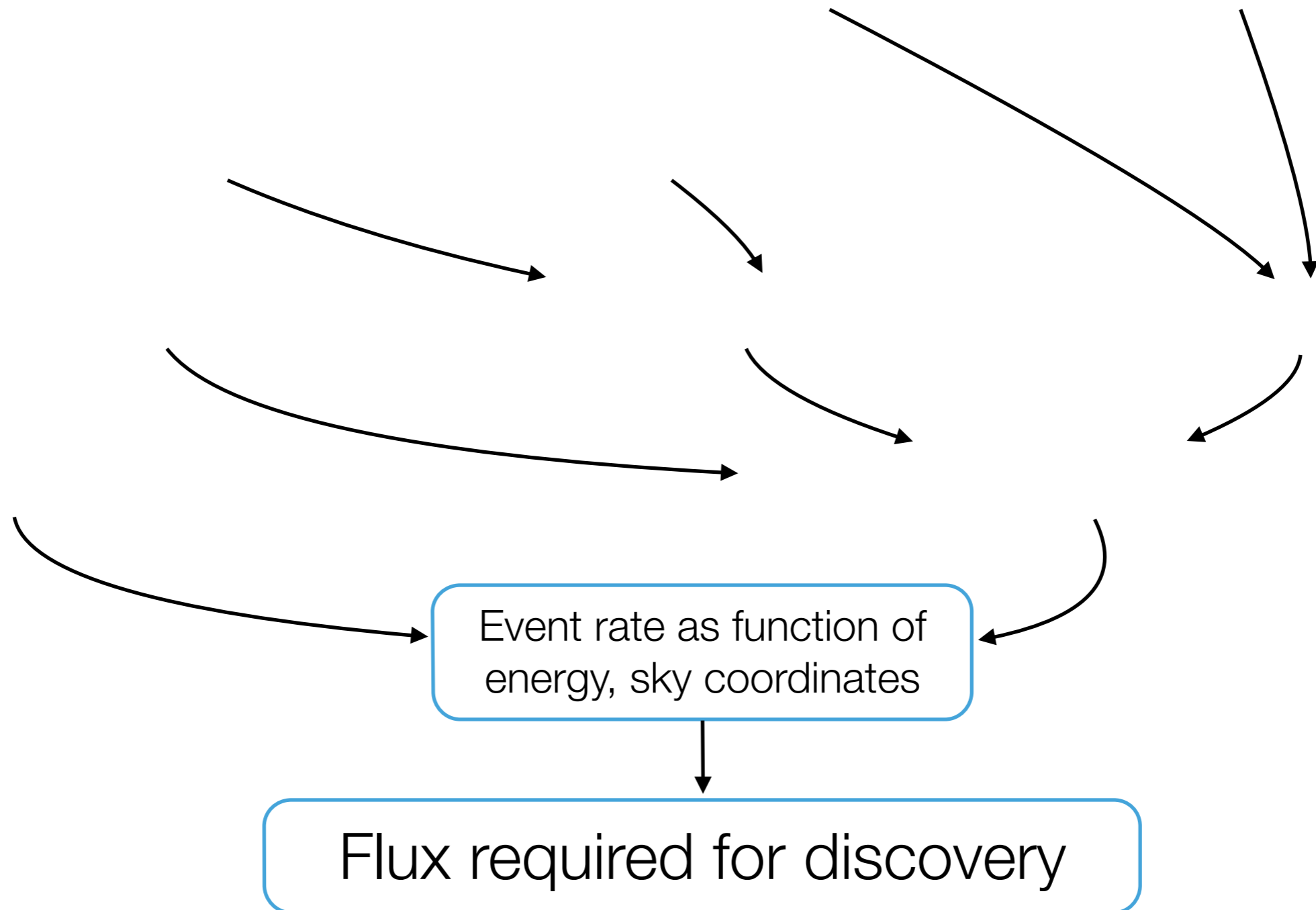

Example: steady point sources

Search: steady point source in the northern sky, using incoming tracks

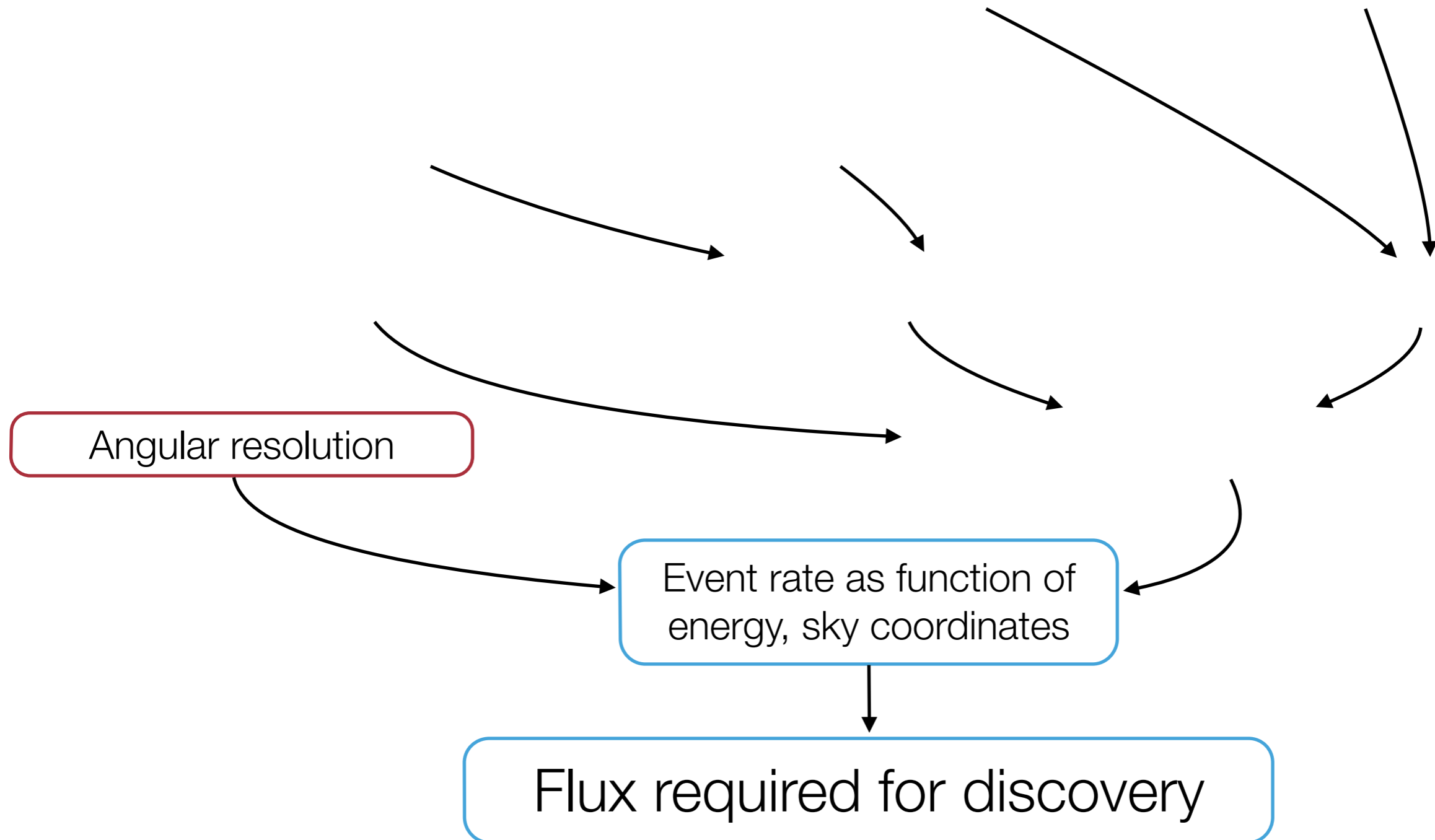

Example: steady point sources

Search: steady point source in the northern sky, using incoming tracks

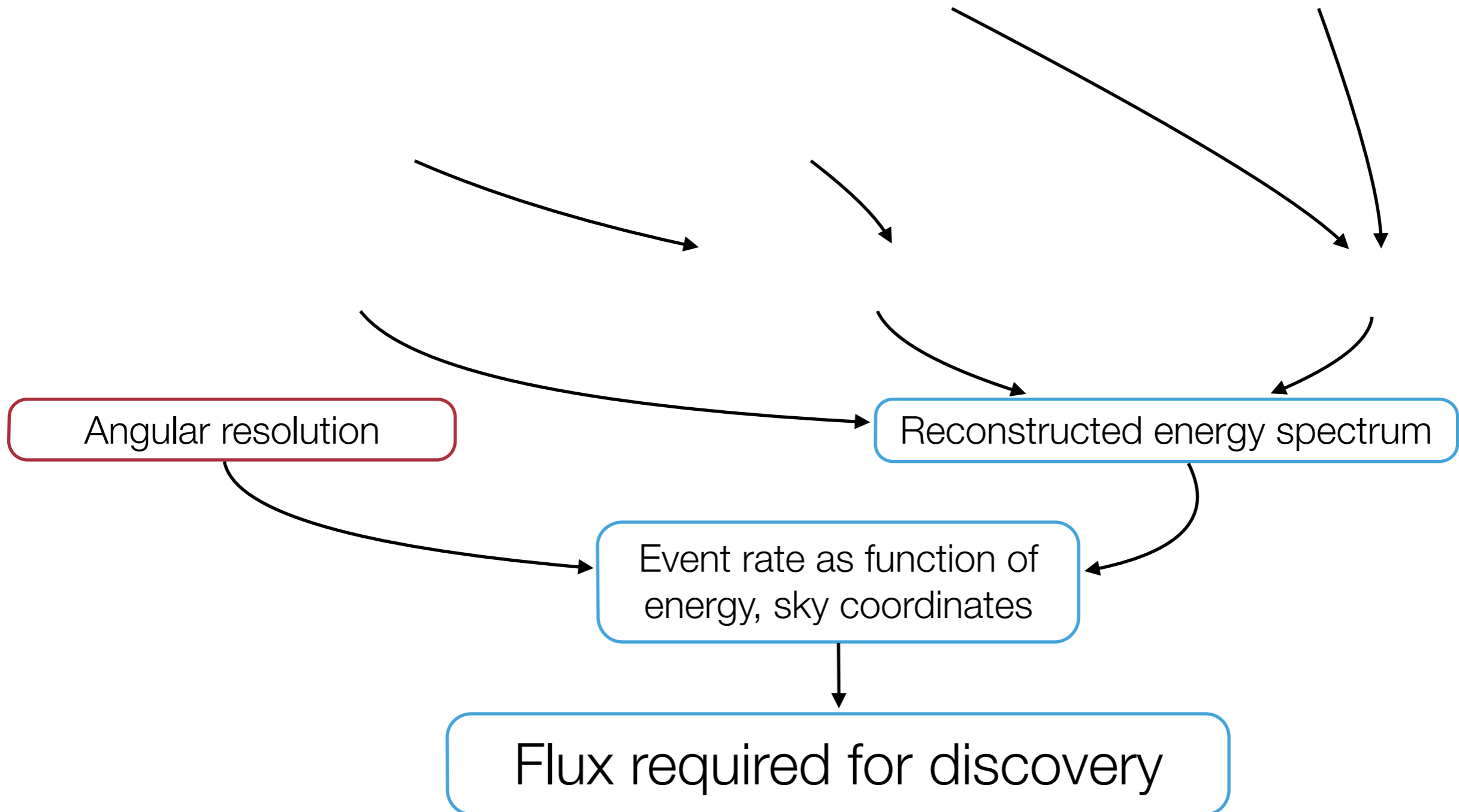

Example: steady point sources

Search: steady point source in the northern sky, using incoming tracks

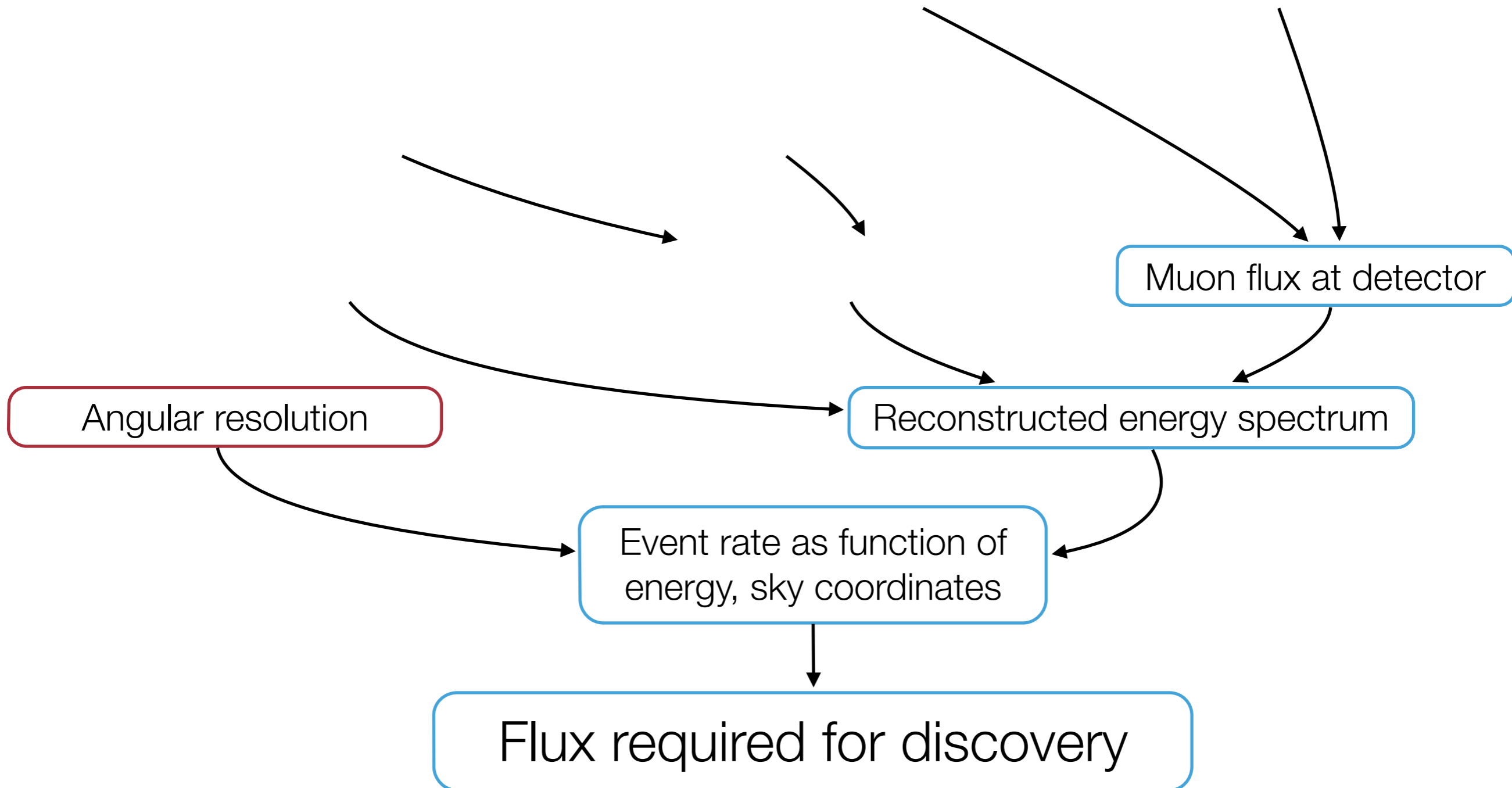

Example: steady point sources

Search: steady point source in the northern sky, using incoming tracks

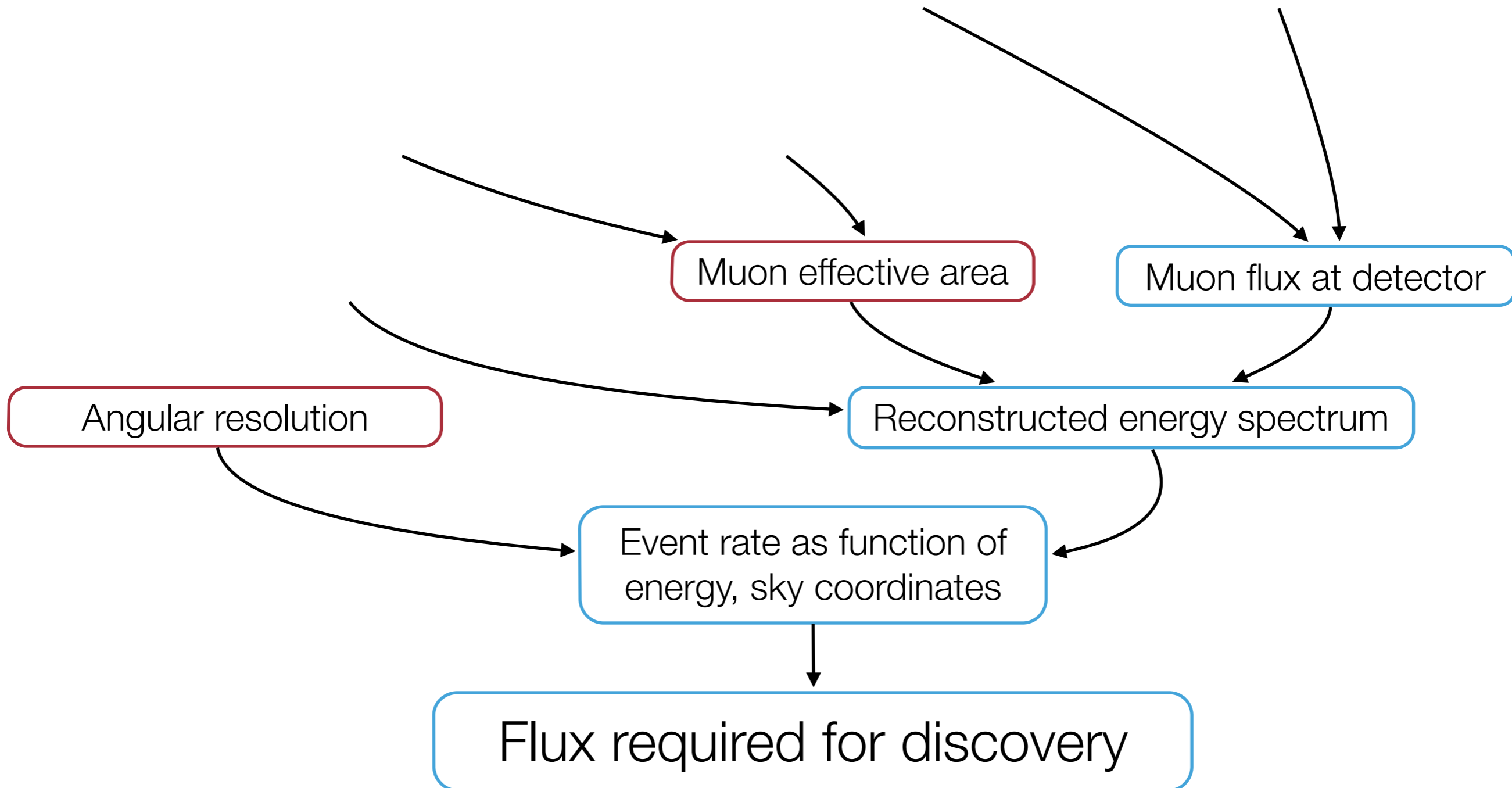

Example: steady point sources

Search: steady point source in the northern sky, using incoming tracks

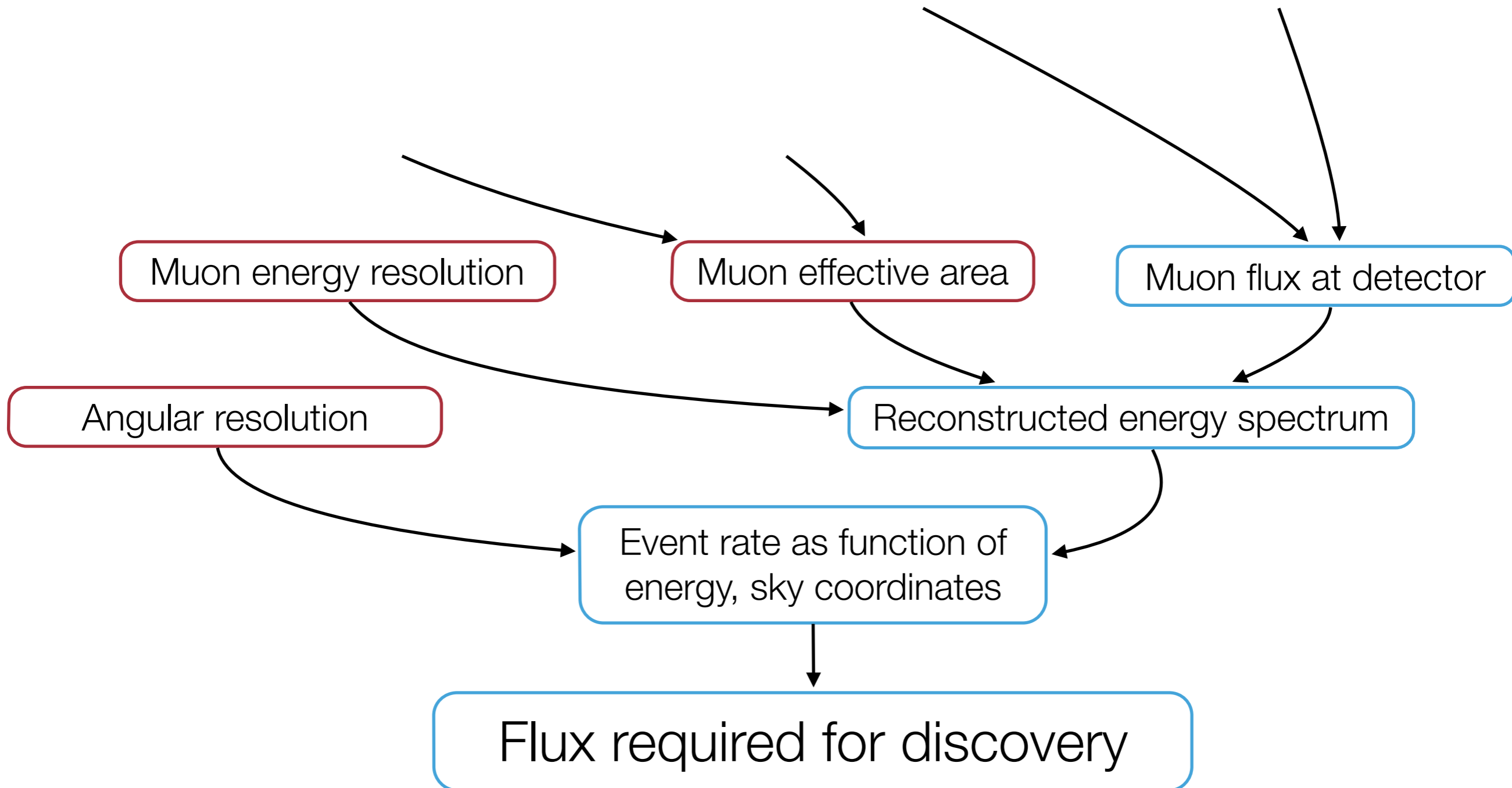

Example: steady point sources

Search: steady point source in the northern sky, using incoming tracks

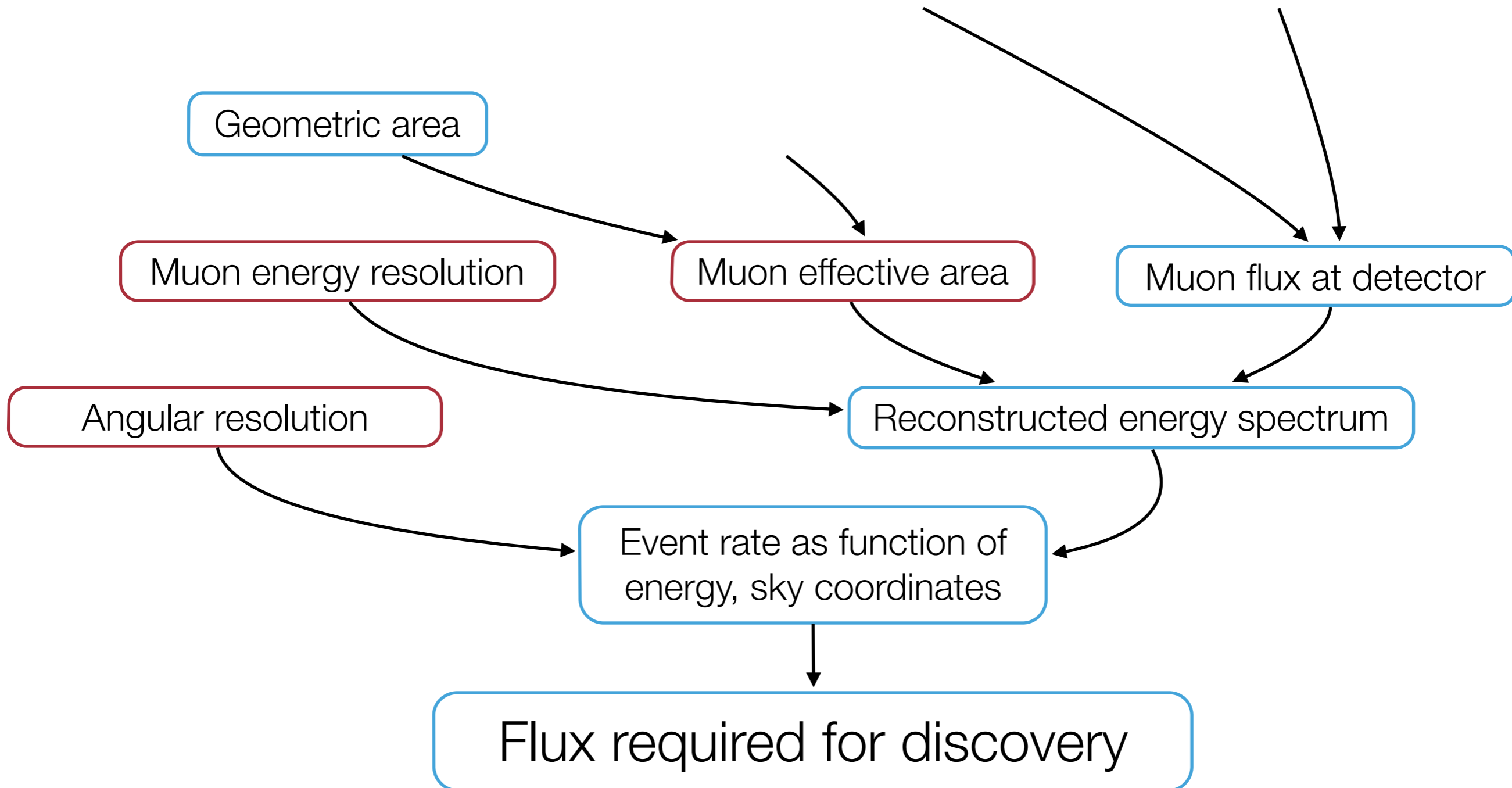

Example: steady point sources

Search: steady point source in the northern sky, using incoming tracks

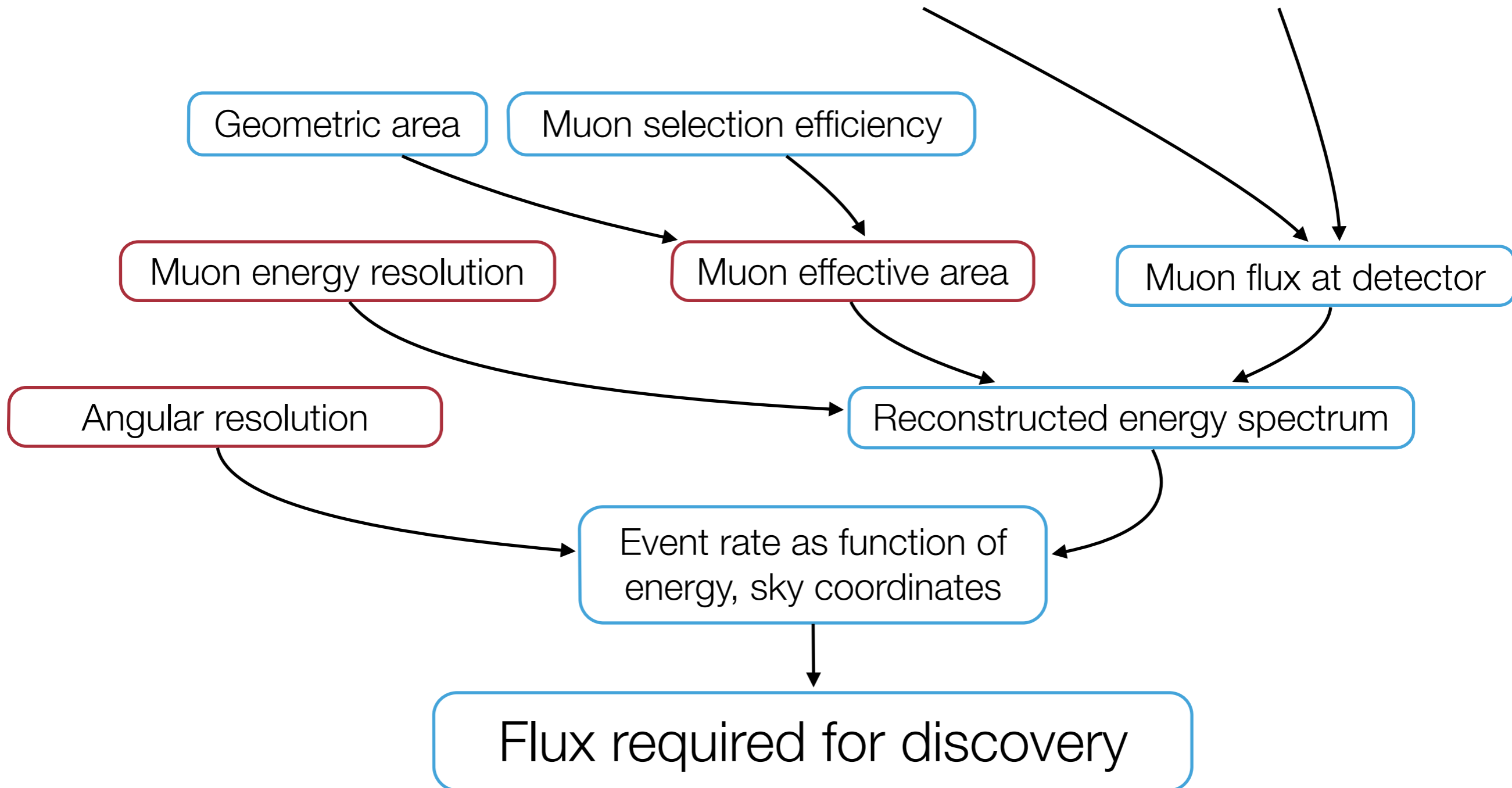

Example: steady point sources

Search: steady point source in the northern sky, using incoming tracks

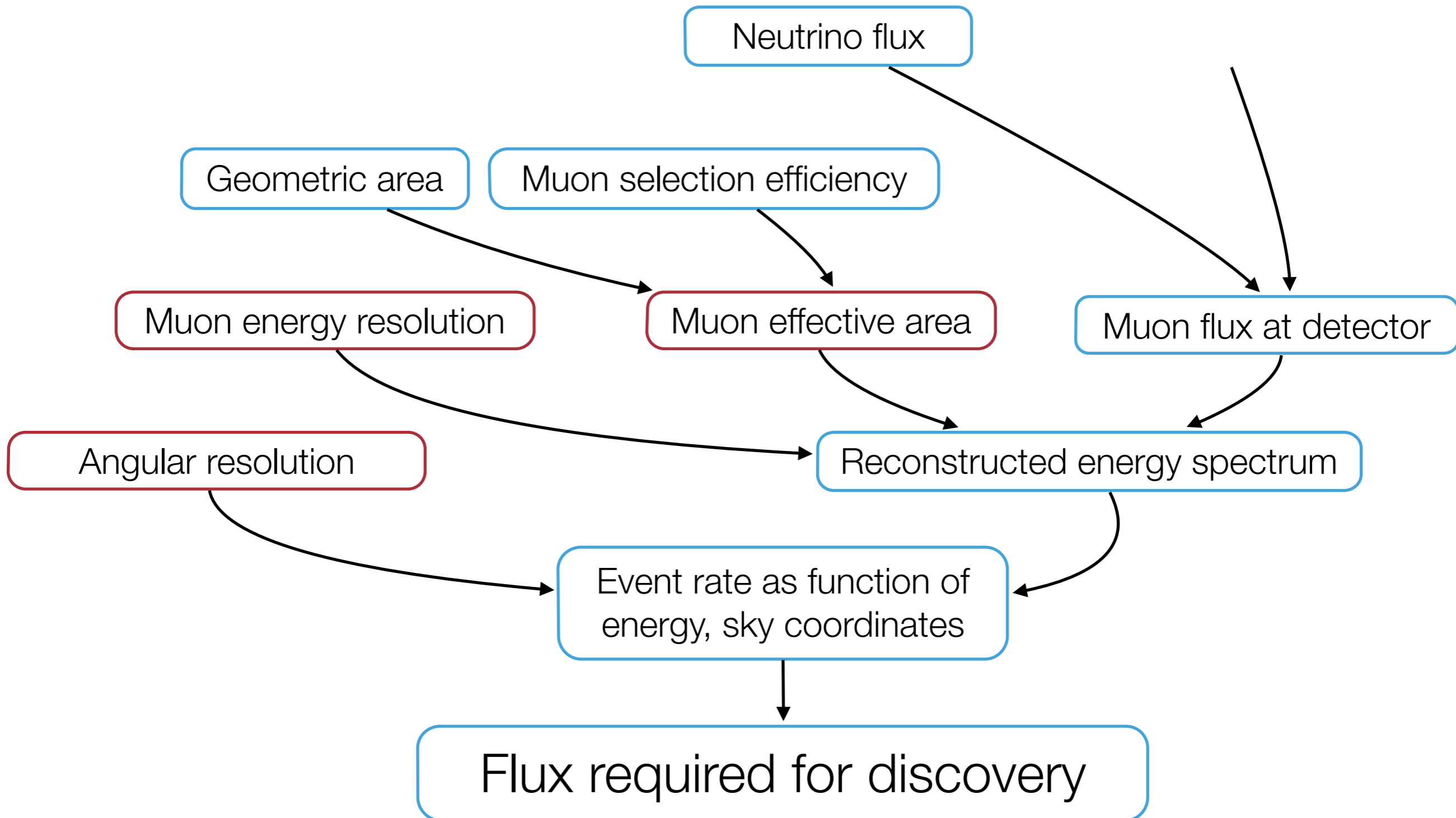

Example: steady point sources

Search: steady point source in the northern sky, using incoming tracks

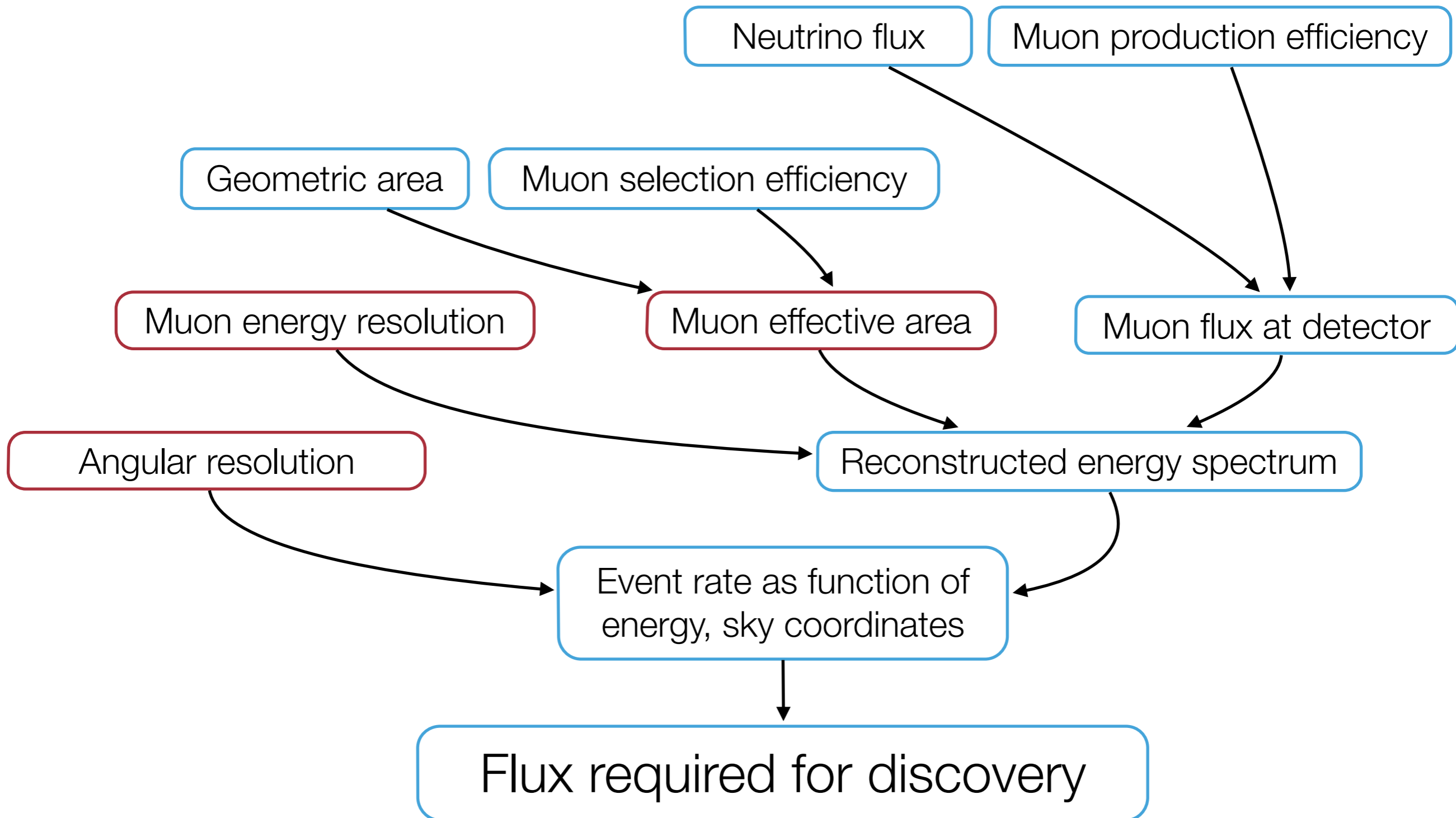

Point source survey volume (4 year PS paper)

