

Strategies on the energy frontier – High energy optimizations and future plans

A. Karle
May, 2009

Strategies

- Optical enhancements
 - HE86 – IceCube with optimized configuration of last 9 strings
 - HE110 – some design studies
- Radio detector strategies for cosmogenic neutrino flux and some AGN models (following talks).

IceCube - Enhancement strategies

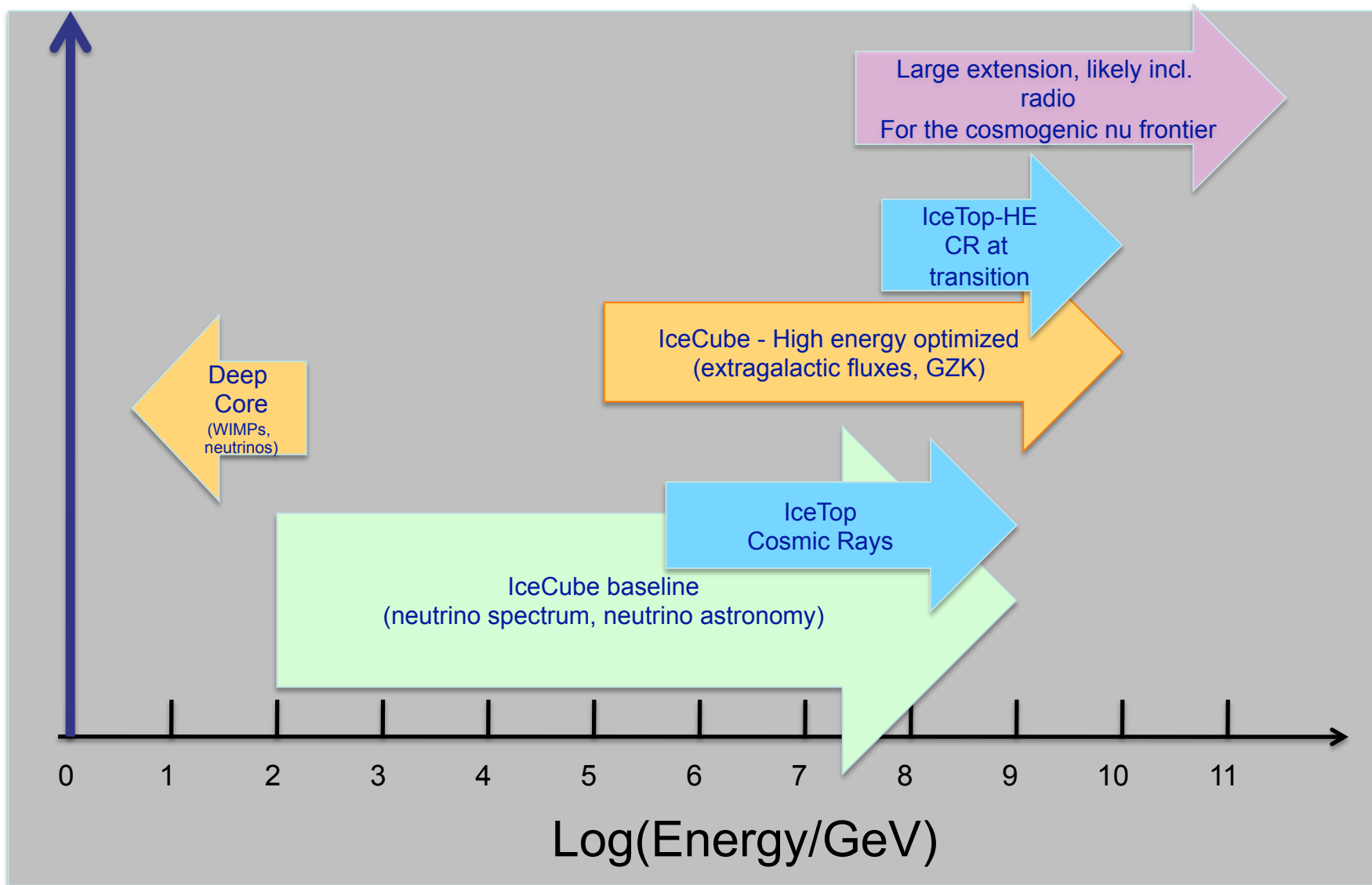

Optimizing end configuration of IceCube for lower and higher energies

- Low energy optimization, 10 to 100 GeV, is covered very effectively by Deep Core
- High energy optimization: configure last 9 strings tuned for higher energy response (\sim PeV)

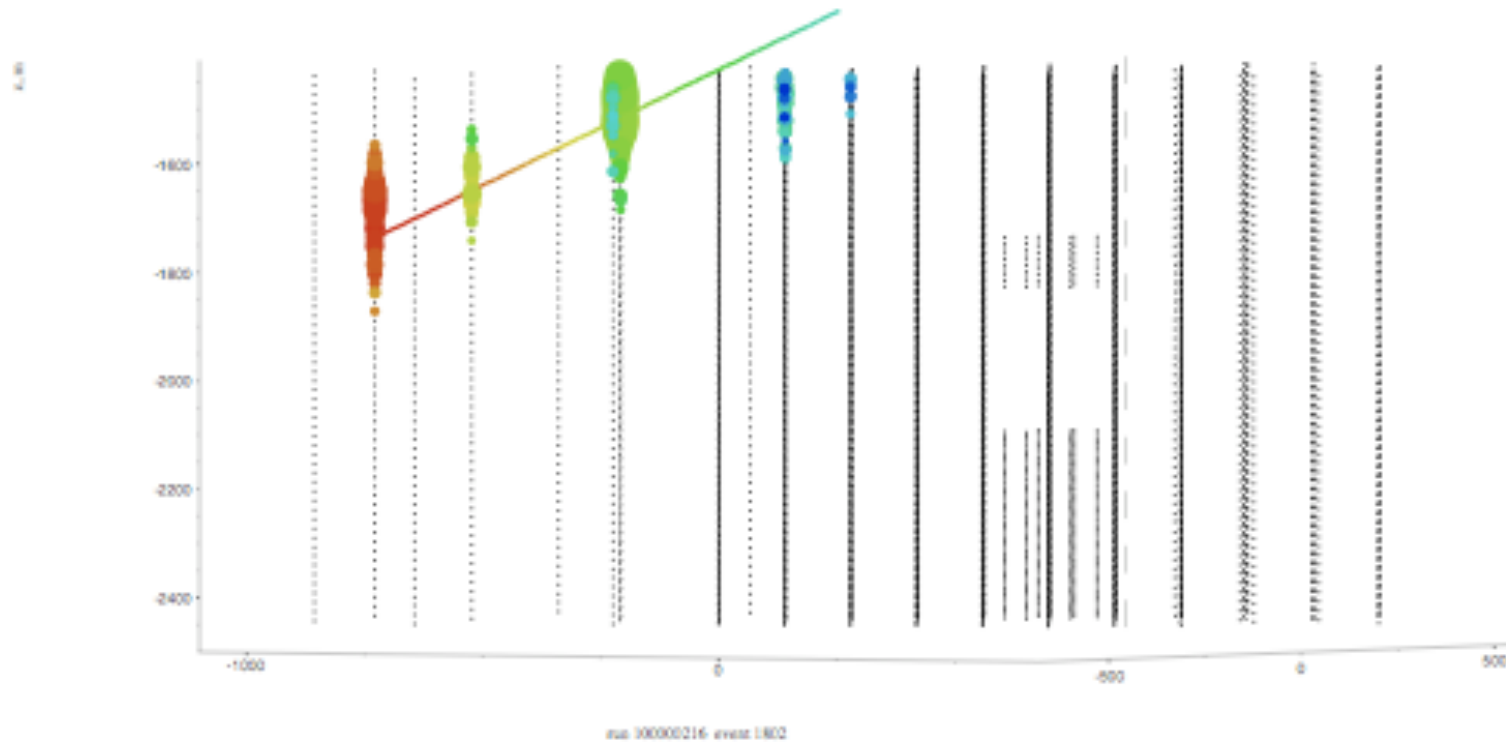

Science motivation

- Extraterrestrial sources associated with HE cosmic rays
- GRBs
 - The primary science goal is a good verification of the GRB fireball model which predicts neutrino fluxes between 0.1 and 10 PeV, with a peak at or above 1 PeV, see for example Anchordoqui et al, [arXiv:astro-ph/0703001](https://arxiv.org/abs/0703001)
 - This extension will add valuable events to the GRB fireball neutrino energy spectrum that we expect to discover and to measure. Should no discovery be made it would rule out more decisively GRBs as sources if UHE cosmic rays - which would constitute a fundamental result.
- Diffuse and point sources:
 - It will also work for any high energy neutrino flux in that range.
 - The threshold for diffuse fluxes is naturally at ~ 1 PeV
 - Also the significance of point source analyses is dominated by events above 100 TeV for an E^{-2} spectrum.
- Cosmic rays above $1E17.0$ eV
- Cosmogenic neutrinos (and neutrino cross section)

IceCube 22-strings: ν flux calculations

- June 2007 - April 2008
- 41 satellite-triggered northern bursts (mainly Swift) with usable IceCube data
- Calculation of individual burst spectra (Waxman-Bahcall GRB flux based on BATSE bursts)

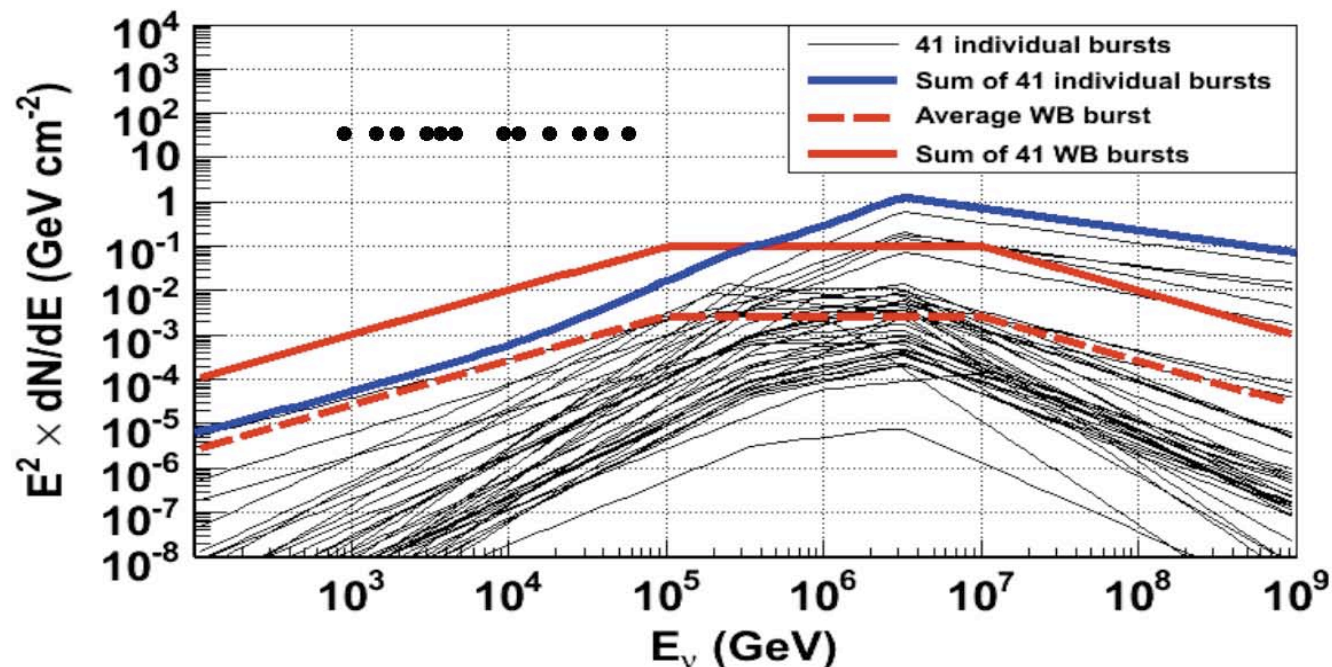

Comparison of WB and AHST spectra

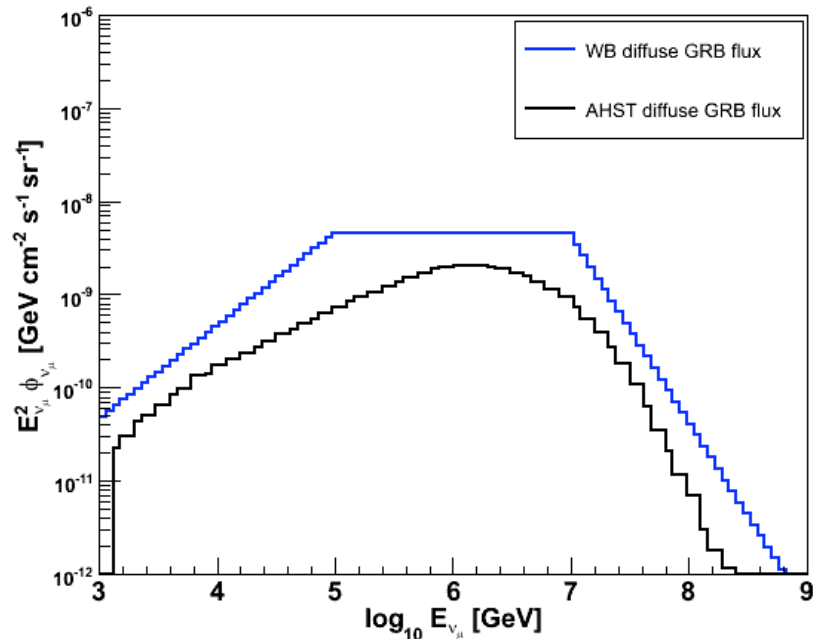

IceCube 86
WB: 10.6 total evts / year
No problem
(170 bursts per year)

Significance of discovery
Is dominated by the high
energy events.
Median energy of events 100
to 300 TeV.

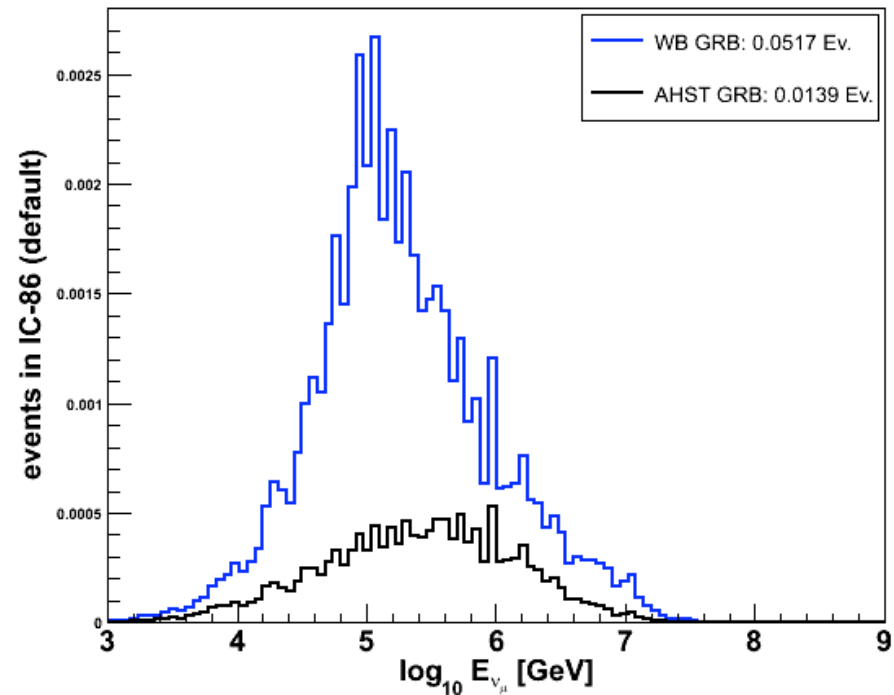

Diffuse E^{-2} ν_{μ} -spectrum peaks at 1 PeV (after atm. Background rejection)

- Neutrino event energy spectrum after energy cut for a 3 year diffuse analysis.
- Signal events peak at $\sim 1\text{PeV}$
- Optimize final detector configuration for higher energy range, to maximize sensitivity of IceCube.

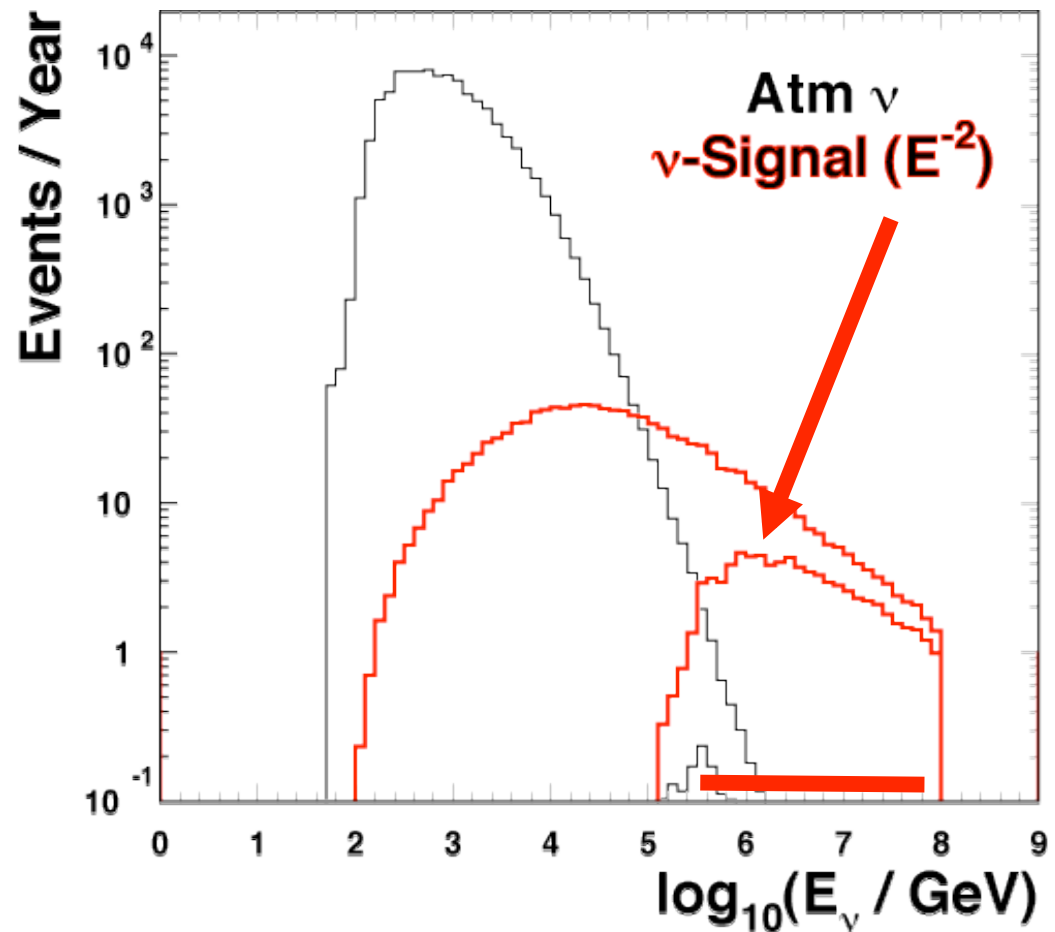

Geometry of high energy optimized configuration

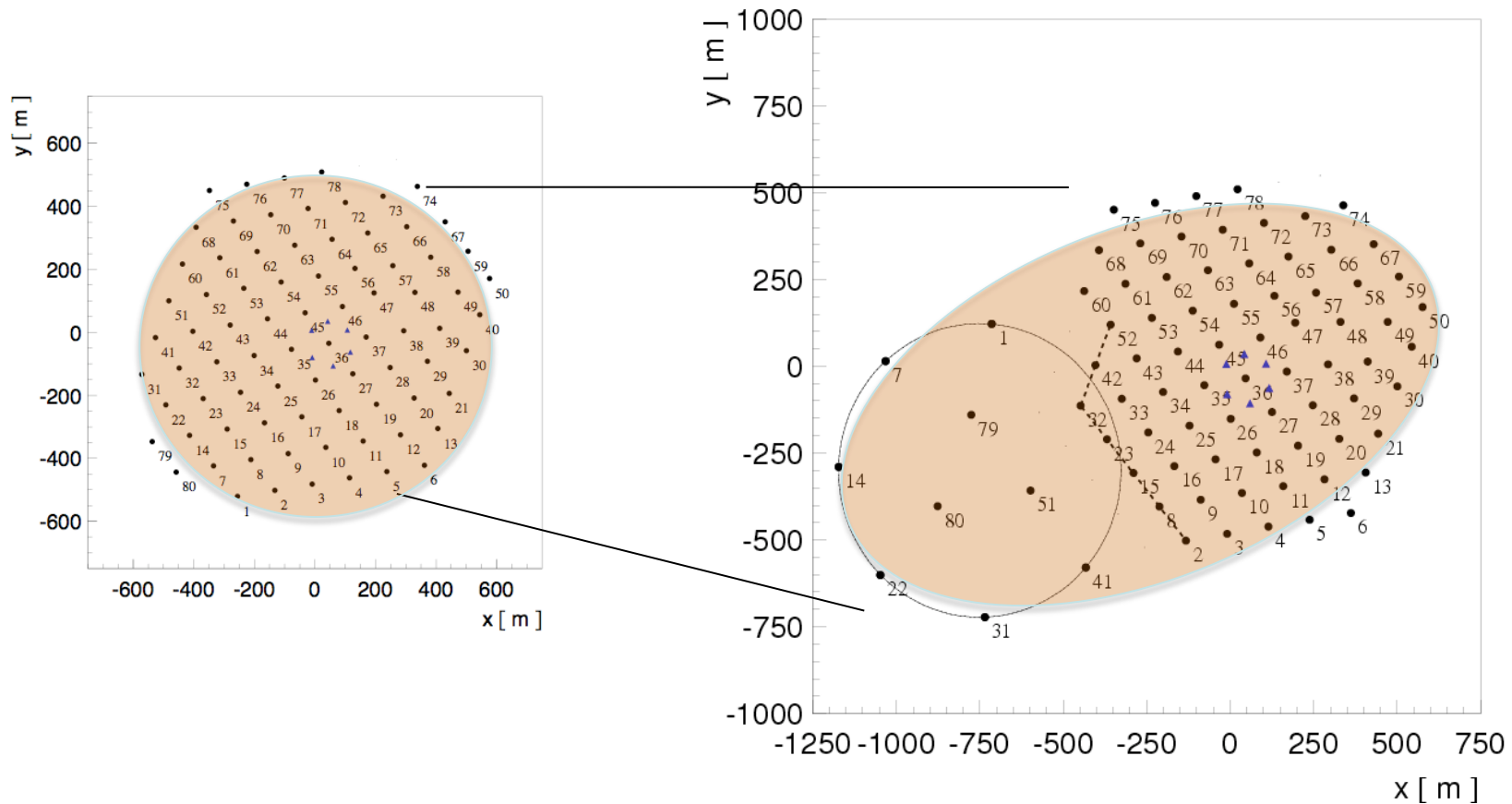

Drilling of 9 holes in the last season inside a circle with radius of >0.4 is possible and not very hard – well, I mean not much harder than usual drilling in conventional spacing.

(Still working on verification of communications over larger distances)

Neutrino effective areas

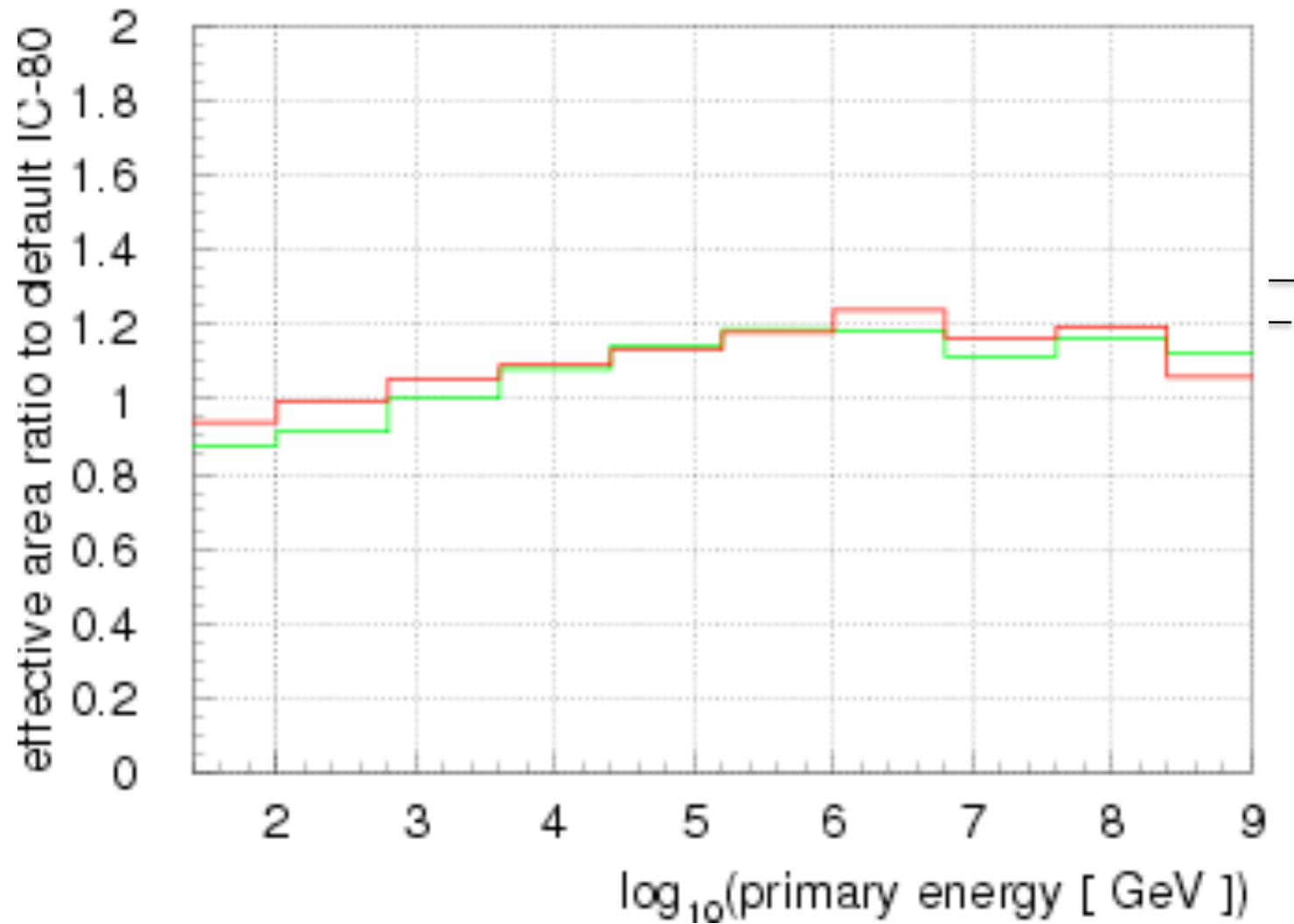

All upgoing directions (90-180 degrees)

Events

Sampled from:

- E^{-1} NuMu Spectrum
- Event selection based on topological trigger and SBM high quality (estimated to be a rather pure sample)
- $\text{COGX} < -100\text{m}$ (increase fraction of events with EX9 contribution)

<http://icecube.wisc.edu/~dima/work/IceCube-HEext/hut/ps/gifs/>

Muon neutrinos: Increase of effective area

Net gain from $\sim 10^{13}$ to 10^{18} eV

Analysis includes requirement of constant angular resolution, event quality and background rejection

RESULT:

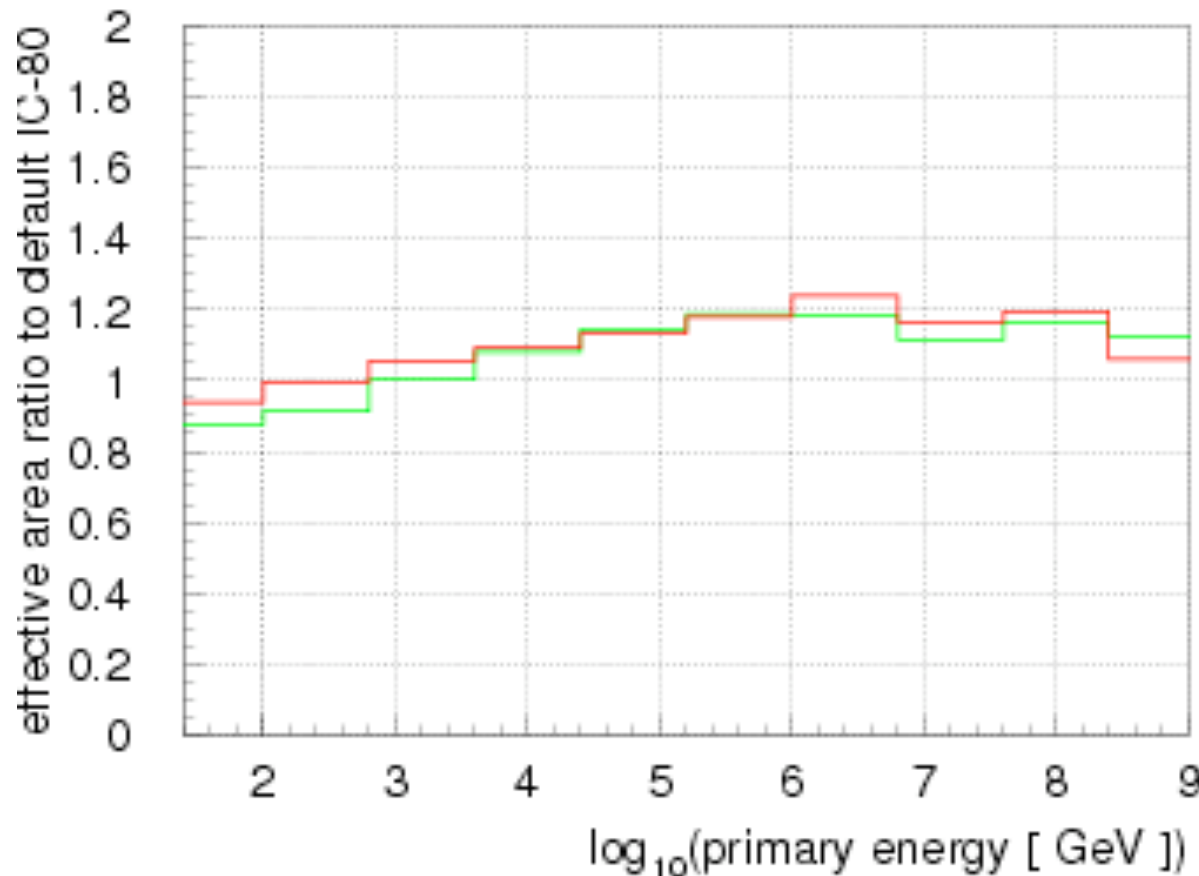

- Gain in effective area 10% to 25%, depending on energy
- IceTop coincidence event rate increases in quadrature above 10^{17} eV
- below 1 TeV small deficit.
- Higher sensitivity for most physics (spectral index > -2.5) except for very steep spectra.

Performance estimates

Performance increase for the proposed geometry in the range energies

- Energy topo tr. (high qual.)
- 1 TeV 1.05 (0.9)
- 10 TeV 1.15 (1.0)
- 100 TeV 1.2 (1.1)
- 1 PeV 1.25 (1.15)
- 10 PeV 1.20 (1.15)

Based on IC22 simulation. The topological trigger rejects coincident background quite effectively.

Increased area: ~20%

IceCube IceTop coincidences above $1E17eV$: increase by >50%

Tau simulation

Signal only,
(no BG rejection)

All tau events,
Probably good measure
for all cascade events

Increase by 25% to 30%
around PeV energies

Pat Toale

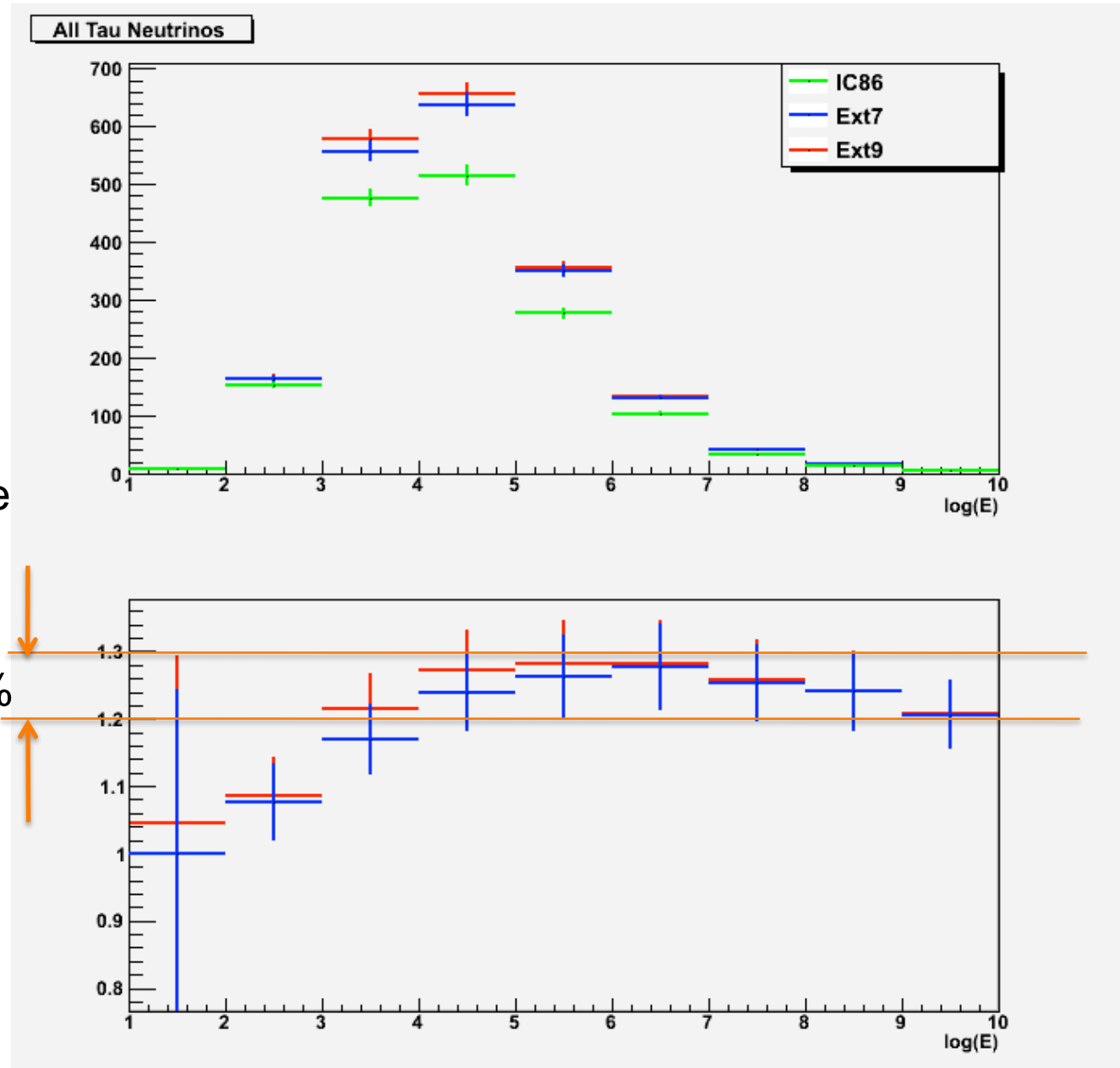

Tau neutrinos - double bang only

Increase by 30% to 40%
around PeV energies

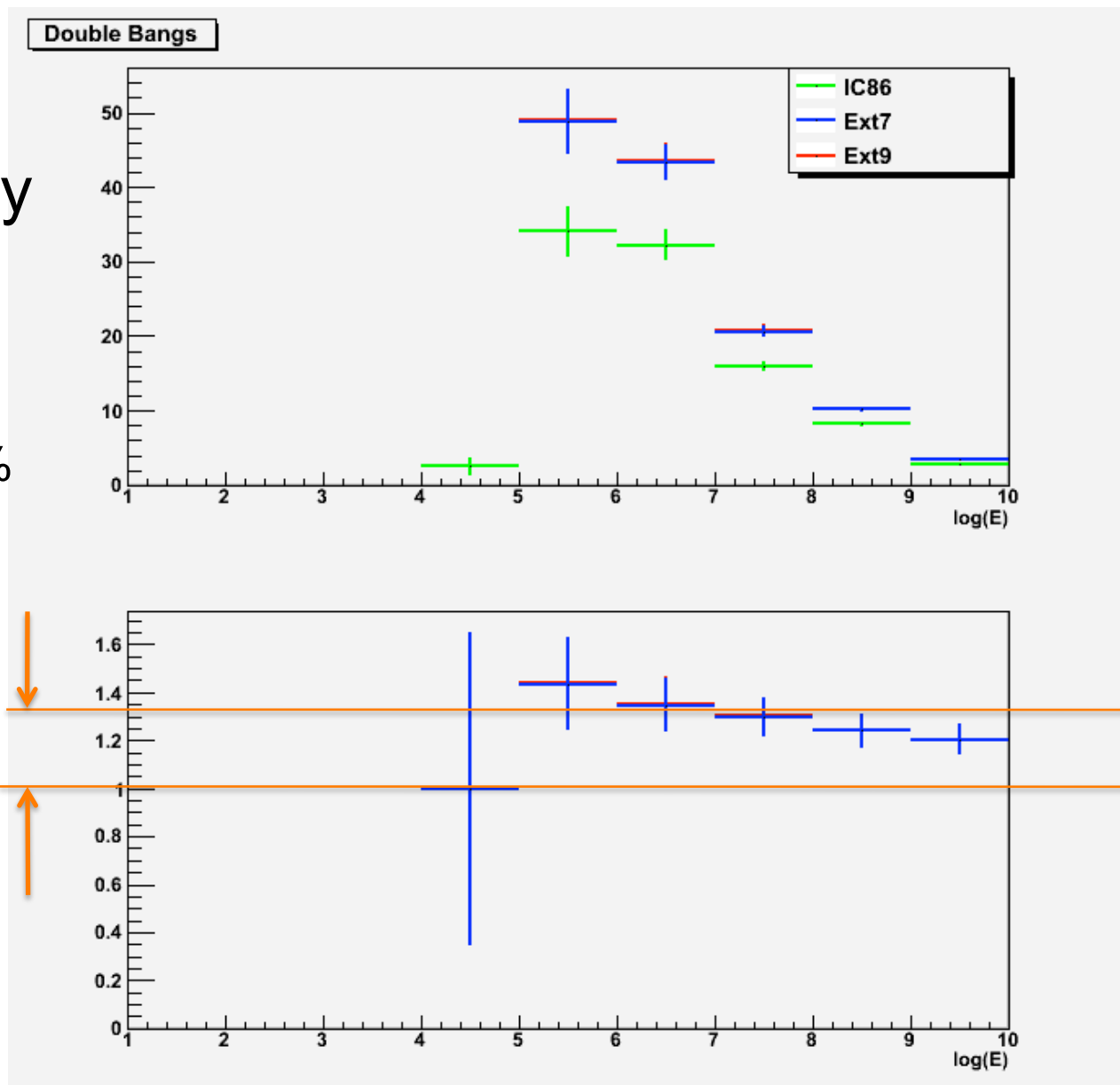

GZK flux event rates

Event rates:

Flux: Engel, Seckel, Stanev, 2001)
= GZK3 in figure

- IC22 throughgoing, 240 days: 0.1 events/yr [no event seen, → ICRC report]
- IC80, total: ~ 0.5 event/yr
- IC110, high energy: ~ 1 event
- $10 \times 10 \text{ km}^2$ radio array: ~ 10 events/yr

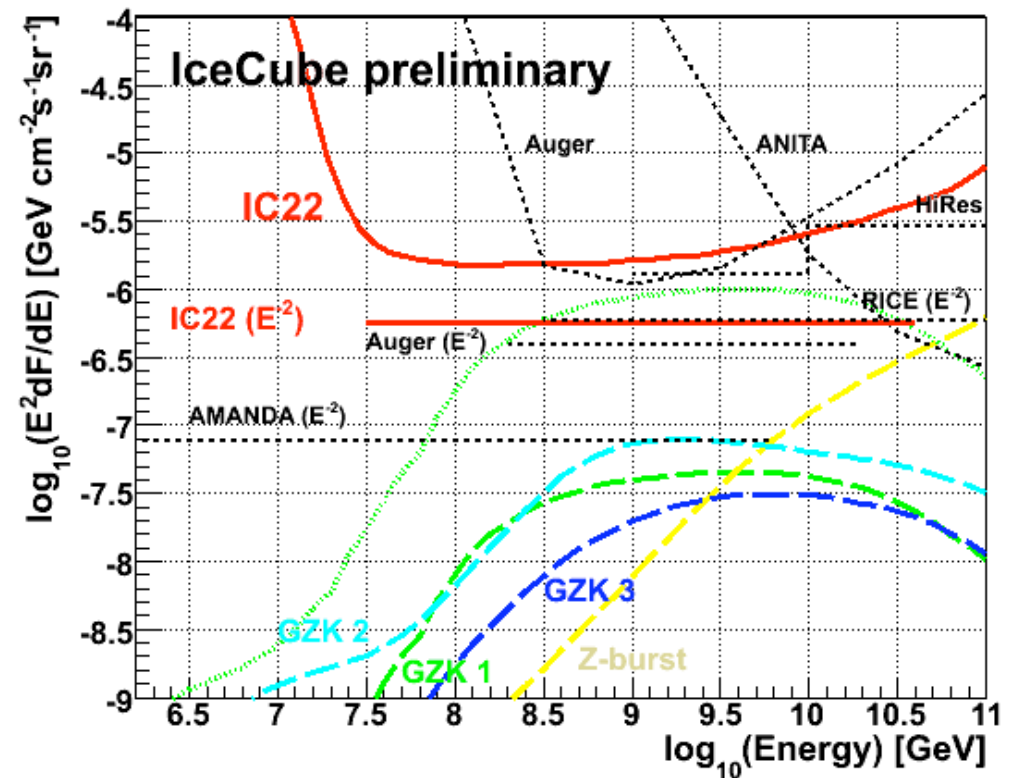

An large optical extension— Scenario for 110 strings

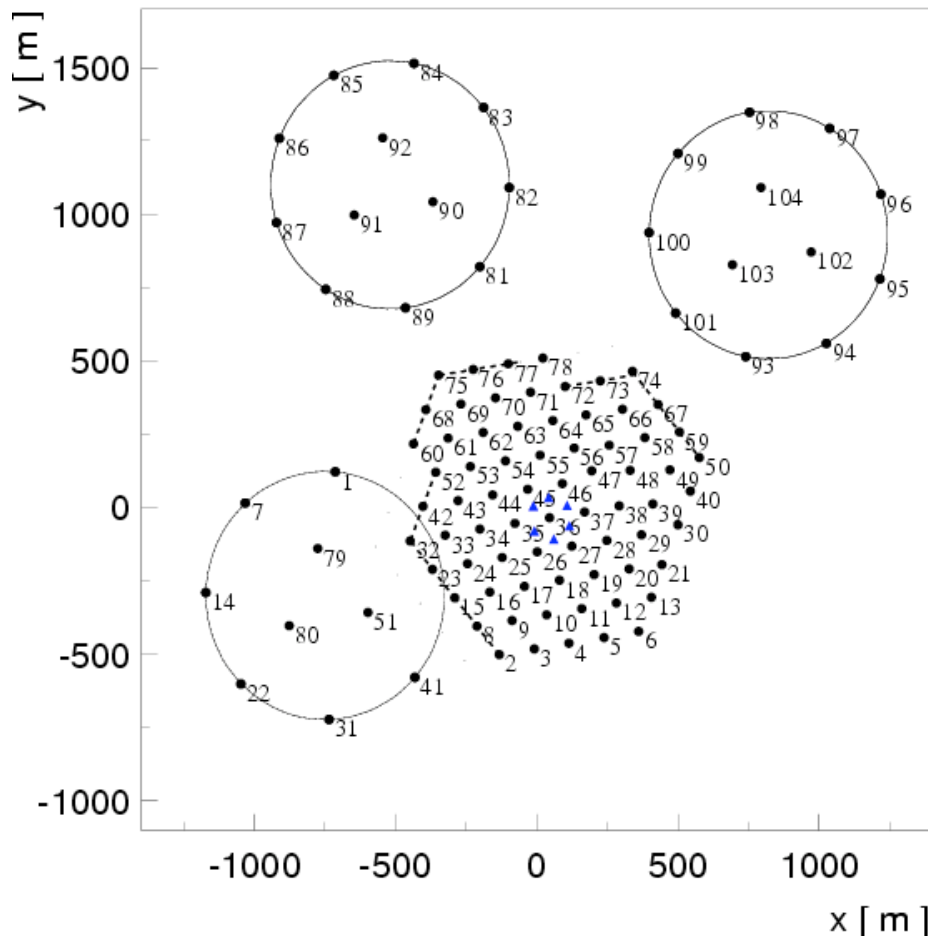

2 extra rings, 12 strings
per ring, fewer DOMs per
string 110 total
Simulating also 16 strings
with 40 DOMs/string

Effective area not well
understood:
Expect factor 1.5 to 2
 km^2 above PeV energies

*Develop plans but no immediate
proposal consideration
unless new information,*

Diffuse fluxes limits at higher energies

Figure modified from

[arXiv:0712.1909]

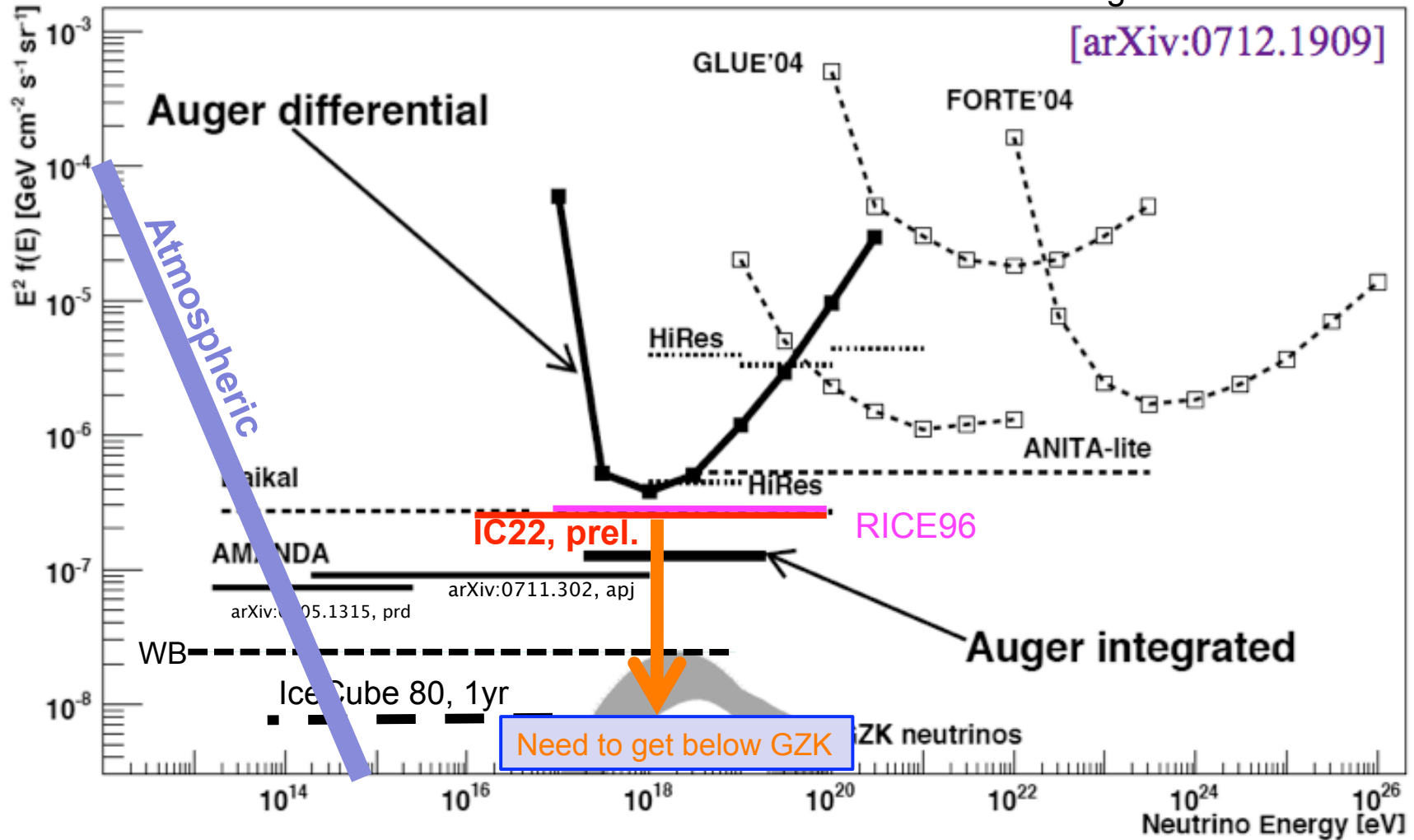

Future possibilities UHE Radio detection around IceCube

- GZK neutrinos ($10^{17-19.5}$ eV), at lowest possible cost: Fluxes may be very low, plan for few events/100km³/yr
- Develop technology to scale beyond ~ 1000 km³
- Robust and easy to deploy technology.
- Hybrid events with IceCube
 - Primary vertex calorimetry in radio, HE muon or tau secondary in IceCube

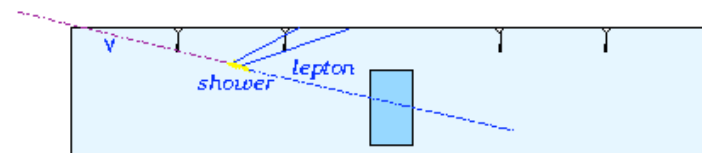
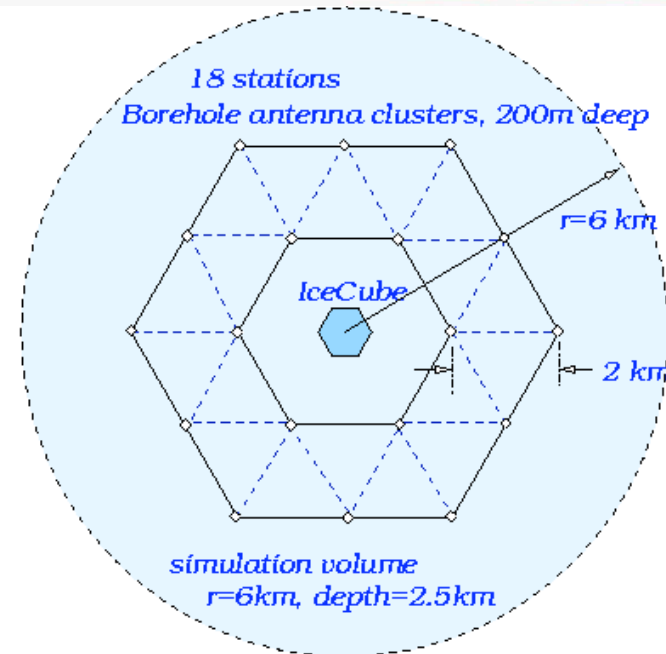
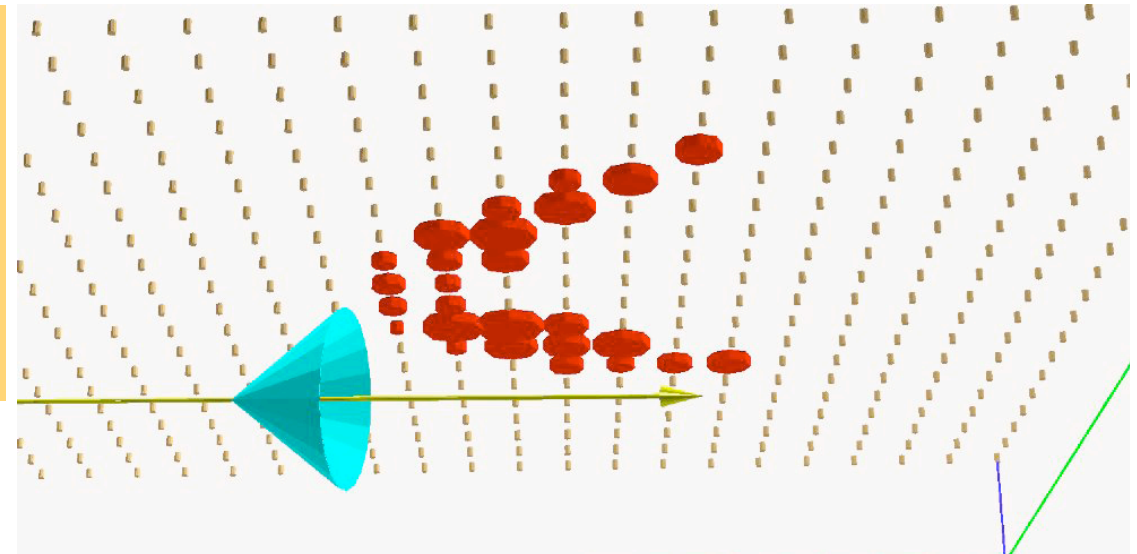

IceCube - Enhancement strategies

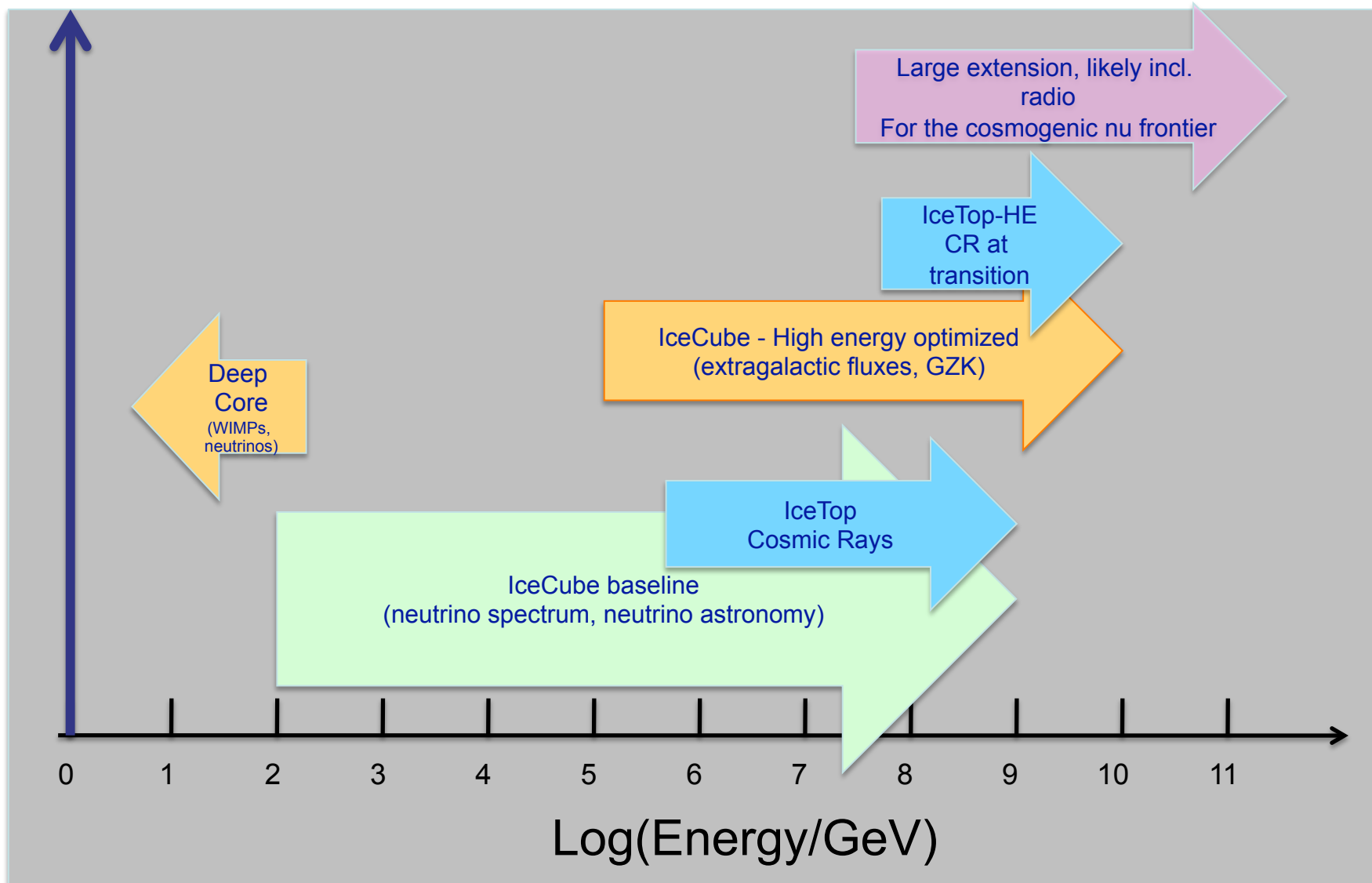

Strategic points

- **HE86** – end configuration optimized for PeV energies.
 - Collaboration is biased towards the high energy optimized configuration.
- **HE110+** – additional 24 - 30 or so strings to enhance the reach of IceCube for extragalactic neutrino sources at PeV energies.
 - Collaboration is developing strategies.
 - Compare with European km³Net perspective
- **R&D for detection of** cosmogenic neutrino flux (GZK) at energies > 100 PeV
 - Collaboration is taking ownership of the challenge and working towards organized approach for a large scale radio detector. (Details from K. Helbing and H. Landsman)

end

