

IceCube Upgrade and Gen2 Software Efforts

Erik Blaufuss // SCAP - Jan 27-28, 2021



Why upgrade IceCube?

- IceCube continues to be a fantastic science machine
 - Includes: discovery of astrophysical neutrinos, first evidence for neutrino point sources, neutrino oscillations, cosmic ray physics, BSM physics and more.
- But more science just out of reach:
 - Reduced energy threshold for oscillation searches
 - Nu-Tau sensitivity, PMNS unitarity, sterile neutrinos.
 - Larger samples of astrophysical neutrinos
 - Build a larger detector with larger energy range to observe more astrophysical ν 's

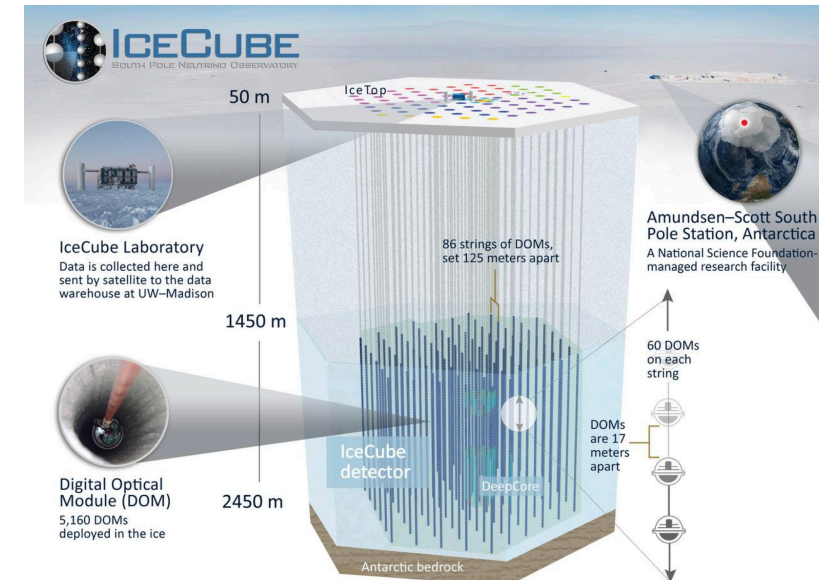

Upgrade strategy

- Funding considerations have made us use a phased upgrade strategy
 - IceCube Upgrade - extension of Deep Core instrumented volume
 - Now in construction
 - IceCube Gen2 – a ~10x increase in instrumented volume, with potential surface array components, and radio-neutrino detection.
 - Proposal(s) and complete preliminary designs now being worked on.
- Global strategy
 - IceCube extensions designed to build upon existing IceCube infrastructure as much as possible
 - DAQ and online systems expanded to include new sensors – long term maintenance and operations support for **1 system**.
 - Icetray data analysis framework extended to include support for new sensors
 - Simulations, data processing, and analysis all done on unified data sample



IceCube Upgrade

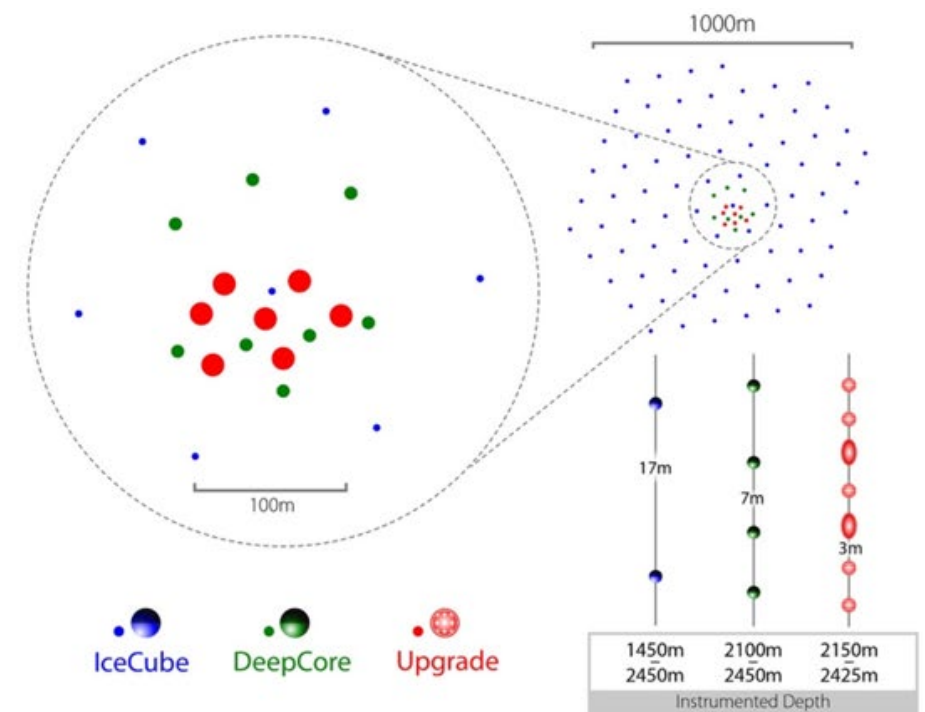
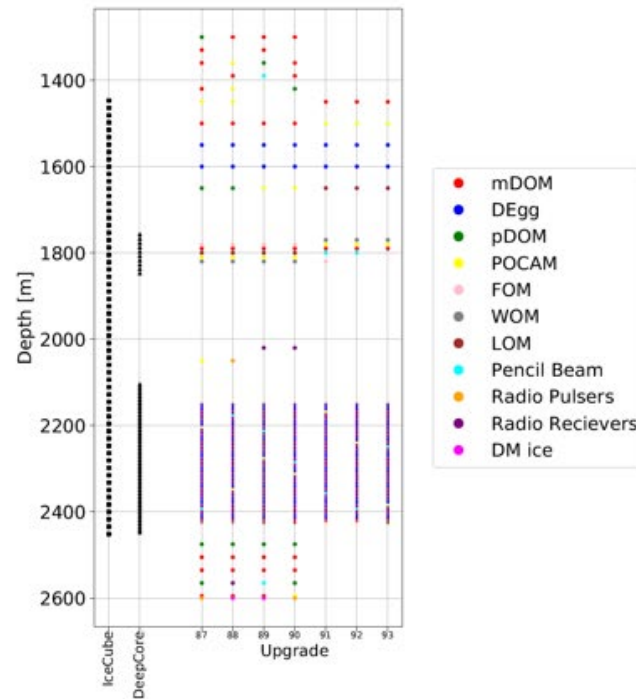

- Upgrade goals:
 - Neutrino oscillation studies – oscillation parameters, Tau-neutrino measurements and confirm unitarity of the PNMS Matrix
 - Detailed calibration of the glacial ice around IceCube – Deployment of many calibration devices with instrumentation
 - New understanding of ice properties directly applicable to 10yr + catalog of IceCube data
 - Next generation (Gen2) research and development platform.
- Deployment: 2023-2024 polar season (+1 year delay from COVID-19)



IceCube Upgrade Instrumentation

- Several new optical sensors planned for Upgrade
 - mDOM - 24 x 3" PMTs
 - DEgg - 2 x 8" PMTs
- New Calibration devices
- Improved understanding of glacial optical properties
 - Far from statistical limits on angular resolution at high energies
 - O(0.1) deg for tracks and O(3) deg for showers
- Cleaner identification of Tau events

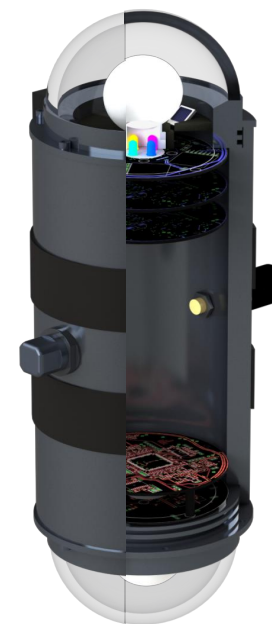
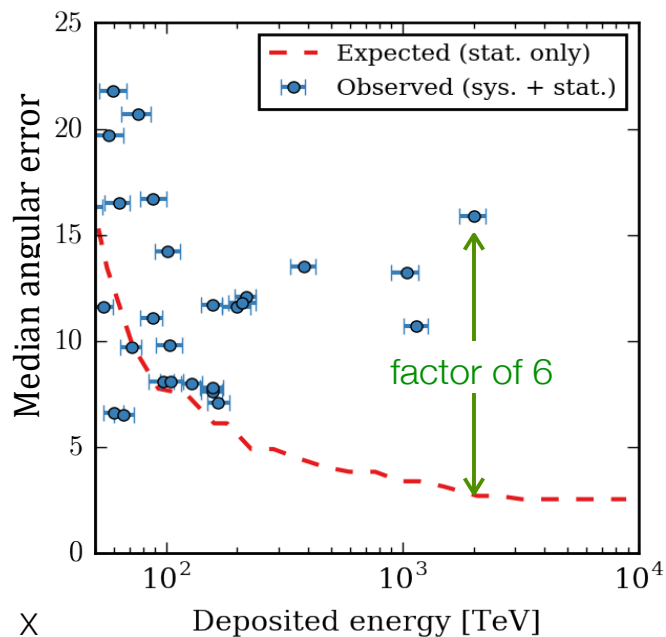

Upgrade Design and IceCube Gen1 Heritage

- IceCube Online and Offline software systems serve as a robust starting point for Upgrade
- Design focused on targeted additions to existing systems
 - Online DAQ and Experiment control
 - Offline Software and simulation
 - Computing and Infrastructure
- New designs strongly follow successful Gen 1 designs as well
 - OM Software
- All tasks are tracked in Upgrade project schedule
 - Almost all tasks provided as in-kind contributions
 - Online: supported by the responsible M&O teams
 - Offline: supported by M&O and wider collaboration efforts

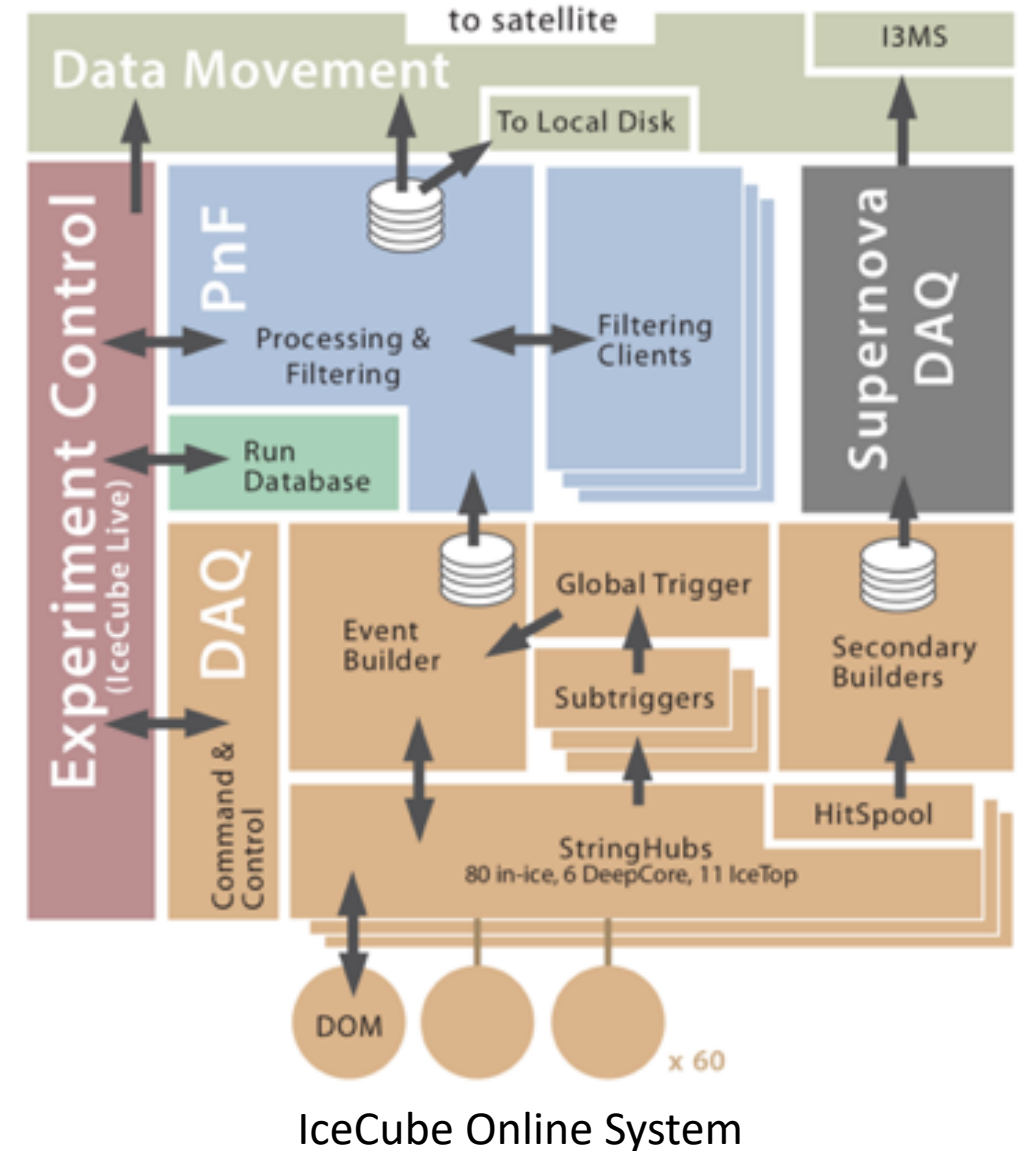

Computing Infrastructure

- Computing infrastructure for Pole and Northern test systems provided as small extensions of existing systems

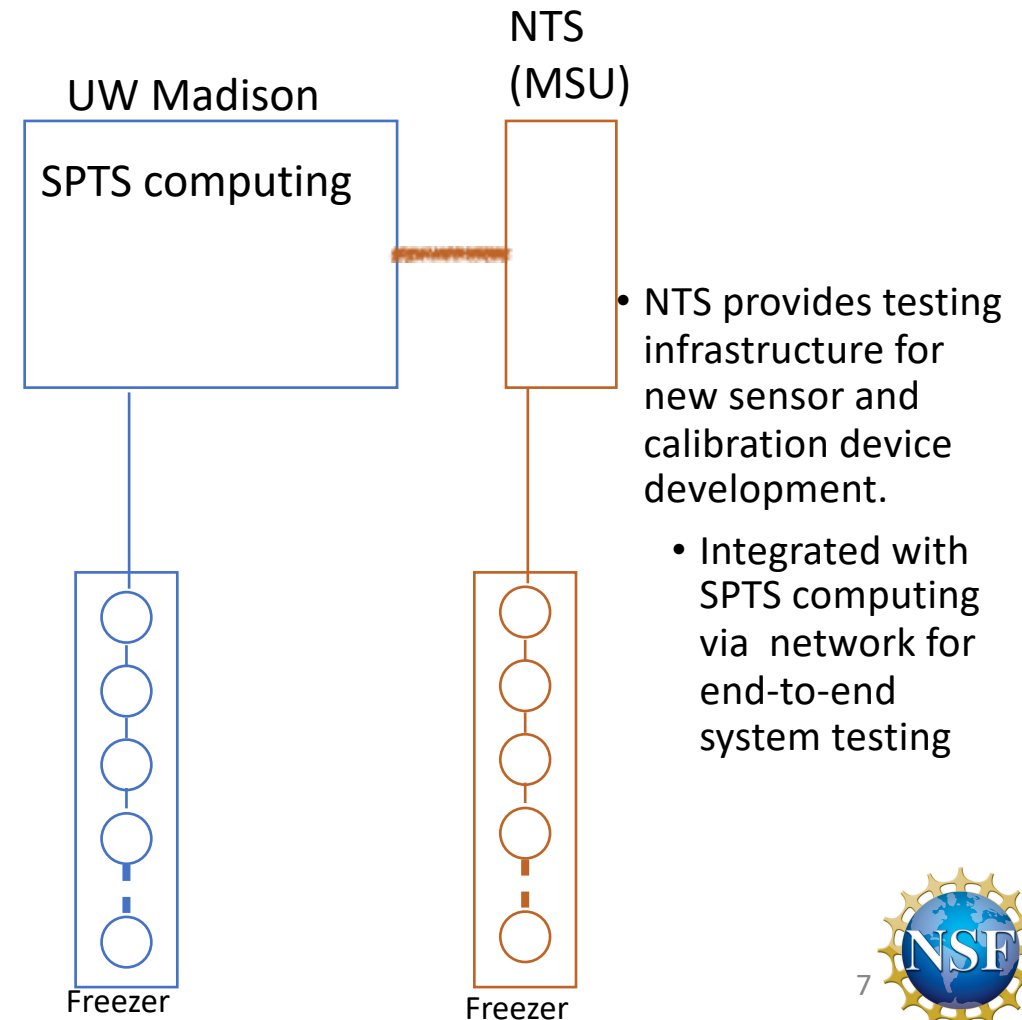
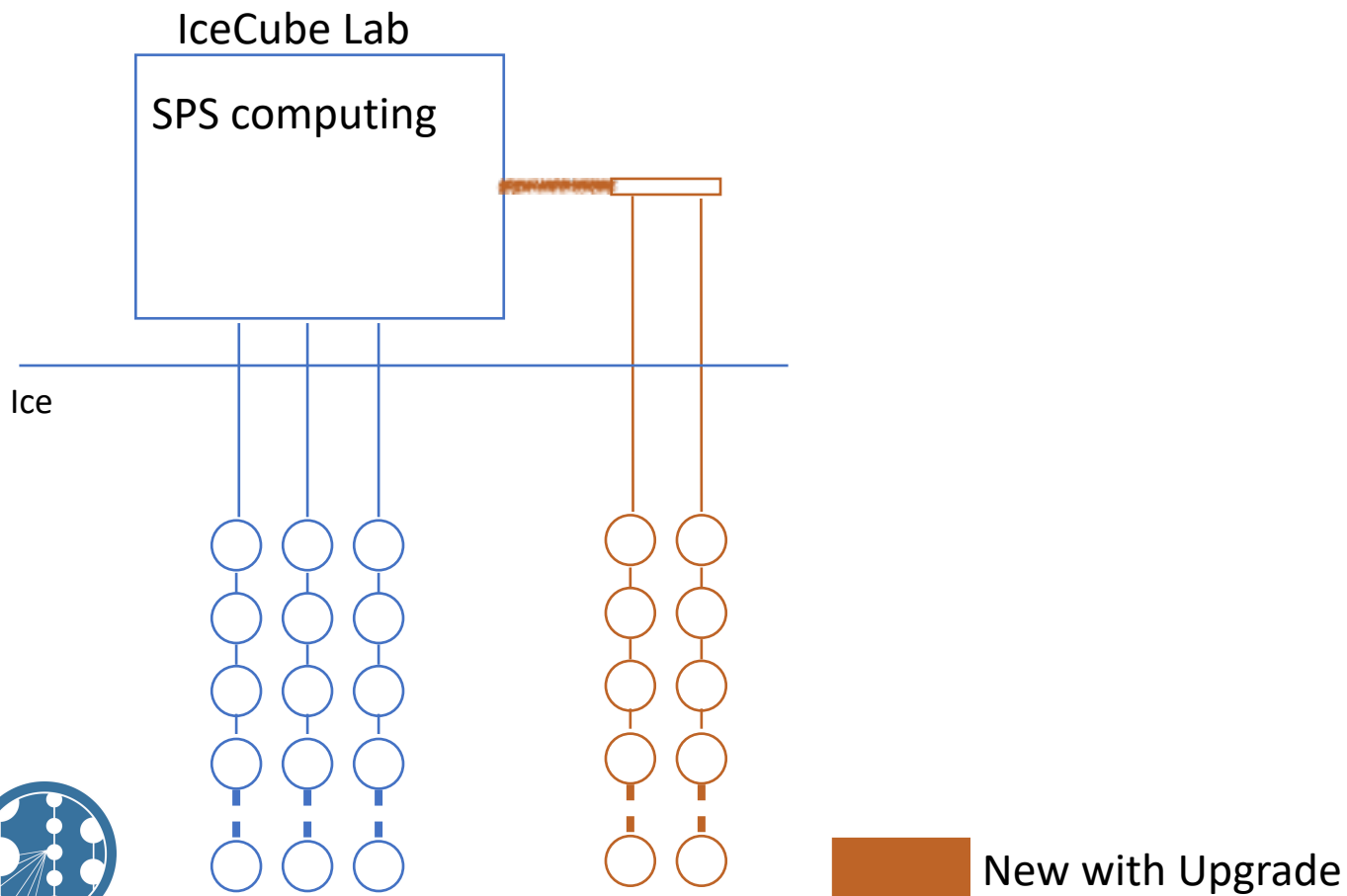

Upgrade – Online impacts

- Currently, IceCube and Deep core:
 - 2.8 kHz overall trigger rate ($\sim 10\%$ is DeepCore)
 - ~ 1 TB/day raw data to long-term storage
 - ~ 75 GB/day L1 (online) filter selected data to satellite ($O(1\%)$ is DeepCore)
 - This L1 data sample seeds all higher-level analyses in the North
- Upgrade estimates:
 - ~ 400 - 500 Hz of additional background triggers
 - ~ 200 GB/day raw (expecting $<10\%$ to go to L1 with simple veto/noise criteria)
- Multi-PMT devices have potential to make copious quantities of data
 - fADC waveform readout for each channel.
 - Noise triggers become more of an issue
 - Both to be addressed with smarter triggering
 - On-OM feature extraction expected to reduce data volumes



Upgrade – Offline/software impacts

- Upgrade OMs bring fundamental shift from 1 PMT channel per OM to multiple PMT channels
 - After 10+ years of IceCube software, many places have this assumption baked into software
 - Early studies for Upgrade performed with simplifications to simulated modules
- IceTray Software framework
 - Being upgraded to remove this assumption (In progress, expected mid 2021)
- Simulation software
 - Adding "as design" implementations of simulated sensor modules (data samples expected mid-late 2021)
 - Additional GPU-based simulation development, computing, and data is required for multi-PMT modules, lower energy thresholds.
 - Improved fidelity of simulation will likely be needed with improved calibration
- Reconstruction
 - Most complicated to update due to symmetry assumptions in used in tabulated responses – likely ongoing for years within collaboration



IceCube Gen2

- Envision a wide-band neutrino observatory
 - 8-10 x larger optical Cherenkov detector
 - Neutrino astronomy and multi-messenger astrophysics
 - Askaryan radio detector array
 - Probe neutrinos beyond EeV energies
 - Surface particle detector
 - Detailed cosmic ray spectrum and composition measurements and veto capabilities
- Several funding strategies being considered

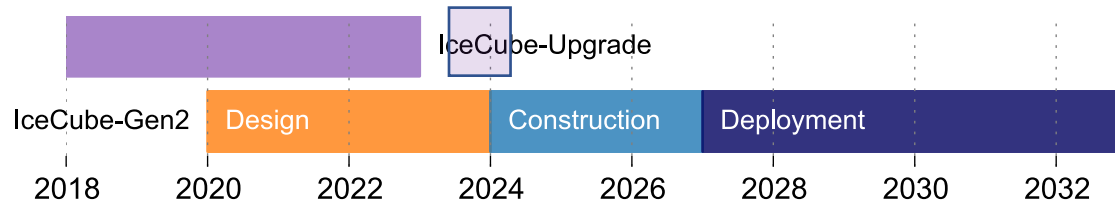
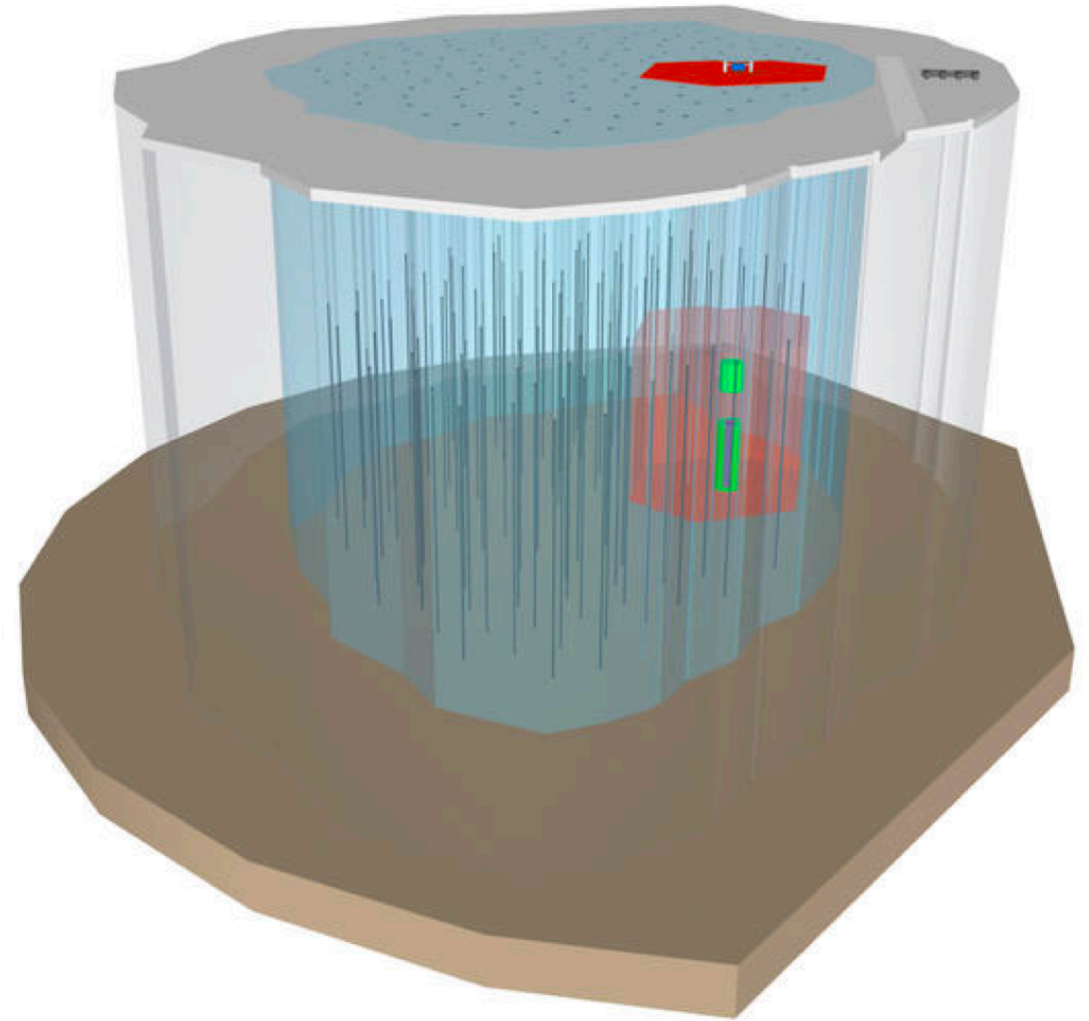

Gen2 Science

- Gen2 will target:
 - Understanding the origin of the high-energy astrophysical neutrino signal seen by IceCube
 - Steady sources and transients
 - Shed light on acceleration mechanisms at work in the high-energy universe.
 - Probe fundamental physics with high-energy neutrinos

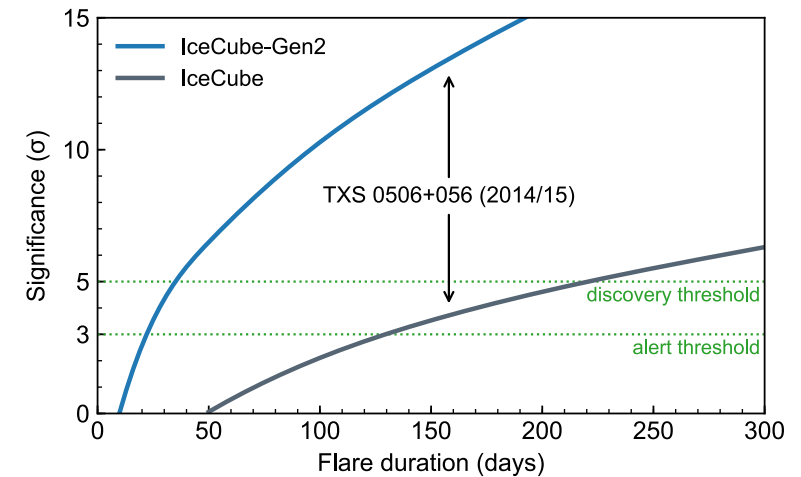
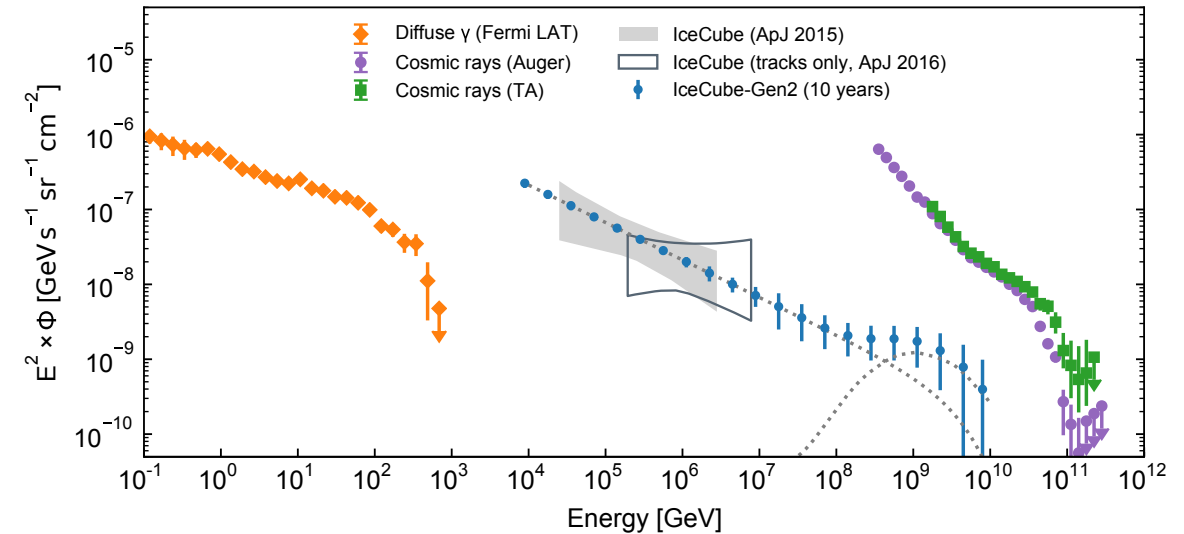

Gen2 design status

- Optical array: add 120 strings with multi-PMT modules
 - Instrumentation design heavily influenced by Upgrade HW
 - Plans for prototype test deployments in Upgrade
- Radio and surface arrays
 - Designs advancing
 - 500 sq km radio array
 - Surface shower detectors for Cosmic ray physics and veto capabilities

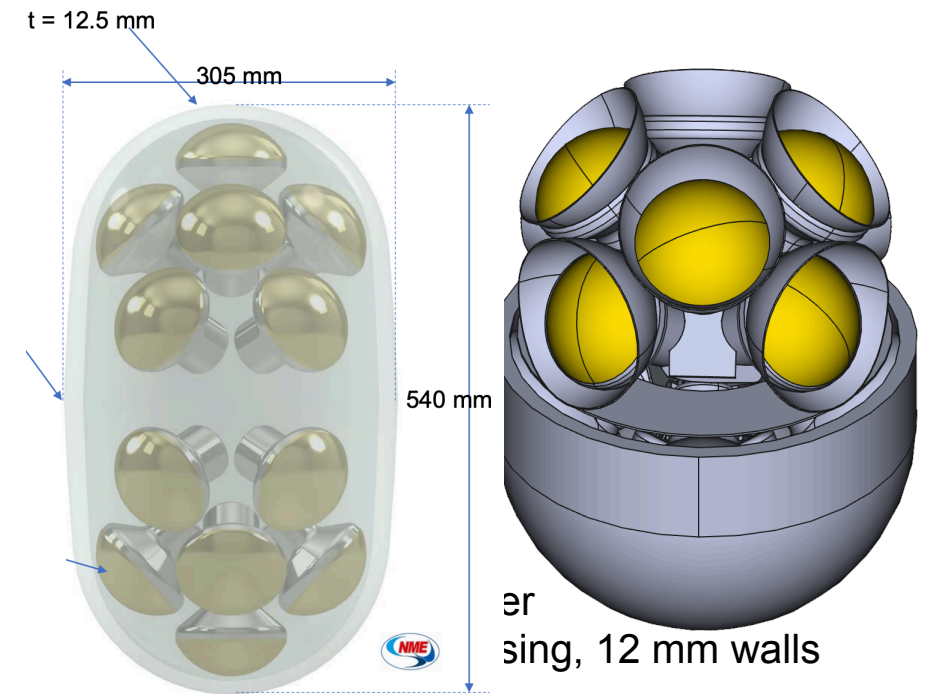
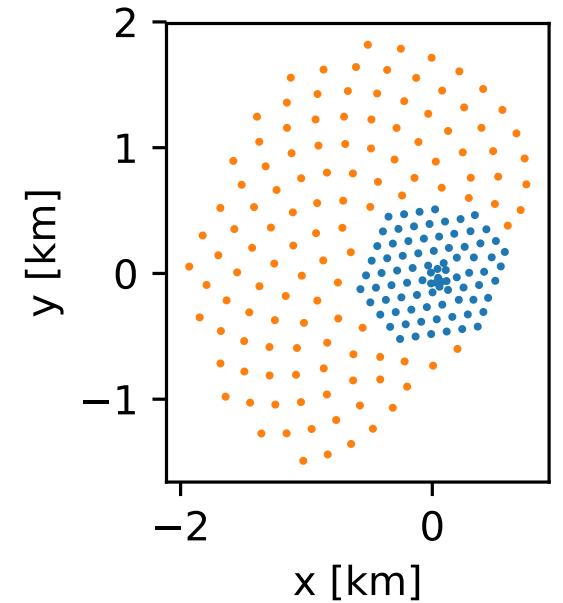

Gen2 – IceCube Impacts

- Online systems
 - Gen2 represents a large extension in data and detector types for online systems
 - Expect modest increase in overall detector data rates (higher threshold of Gen2 array will temper background rates)
 - Fully expect collaboration to want to push thresholds as low as possible
 - Additional heterogeneity of multiple detection channels (optical, radio, surface)
- Offline
 - Software framework, reconstructions and framework
 - Move to multiple PMT channels per sensor will already be complete thanks to Upgrade
 - Additional support for radio signal analysis will be needed
- Data/computing
 - Defining the impact and support needs for these is a critical part of continued Gen2 design work.
 - Quantifying the impact on simulations and data processing is critical next step in design
- Gen2 funding requests **MUST** include additional support for M&O (online and offline) efforts



IceCube Upgrade and Gen2

- Strong team from M&O in place leading the effort to extend online and offline systems and software to support the addition of new sensors to IceCube
 - Upgrade
 - Strong in-kind effort from M&O team to make this happen.
 - Effort and milestones tracked as part of the Upgrade project.
 - Gen2
 - Designs in early stages, but expected to converge in the next ~year
 - Additional resources will be needed to support Gen2 online and offline
 - Understanding our computing needs (online and offline) is critical next step



Thanks!

