

# Online Systems and Detector Operations



John Kelley

March 11, 2019

IceCube M&O Mid-Term Review

# Operations Deliverables

- Keep the detector running!
  - reliable hardware and software
  - fast response time to problems
  - maintenance during austral summer at pole
- Ensure high-quality data to collaboration
  - monitoring and verification of every run
  - good / bad run tracking
- Support continued expansion of IceCube science
  - new features in software systems (e.g. multi-messenger)
  - design for integration of future detector expansions

# IceCube Online Overview

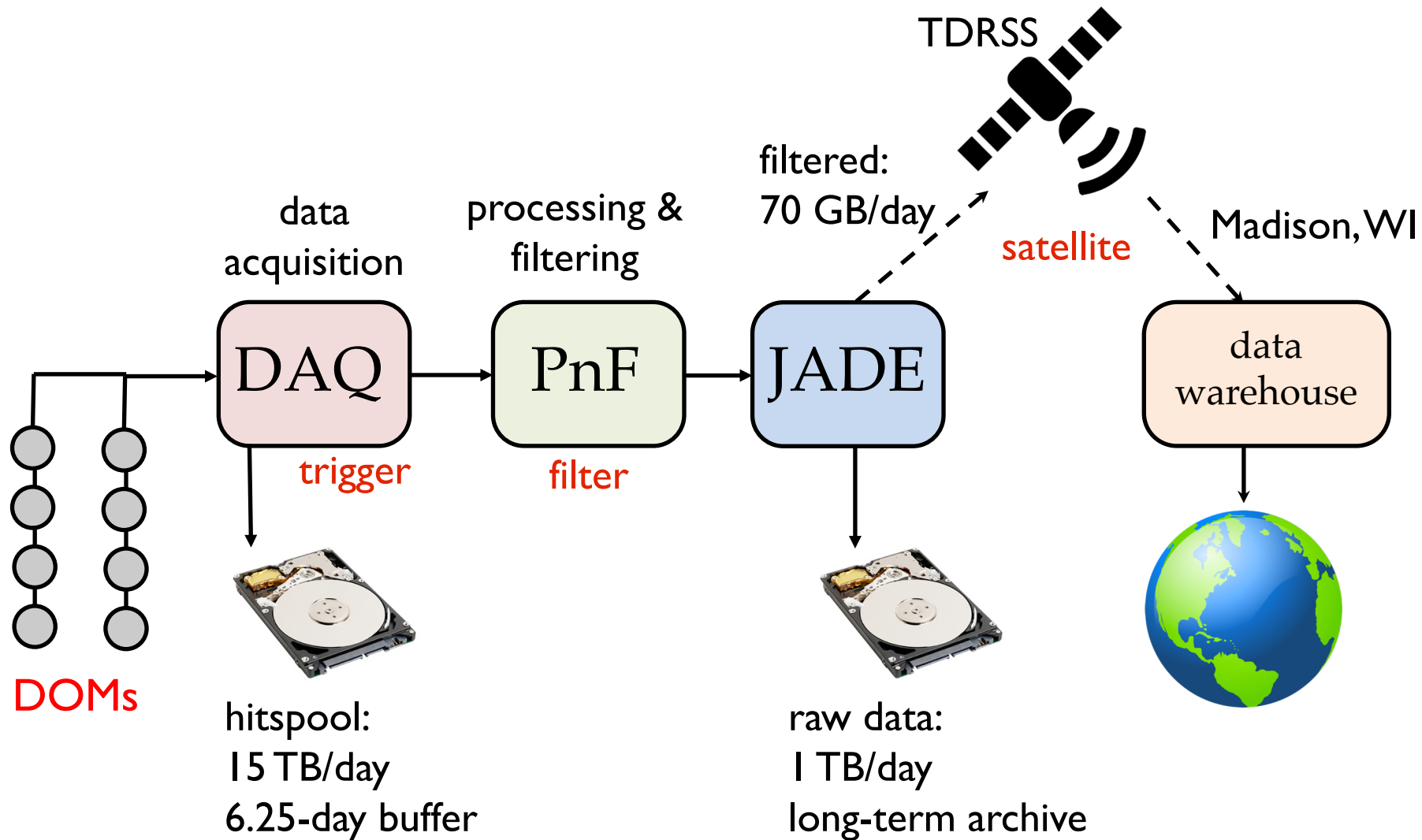

# Triggers and Filters

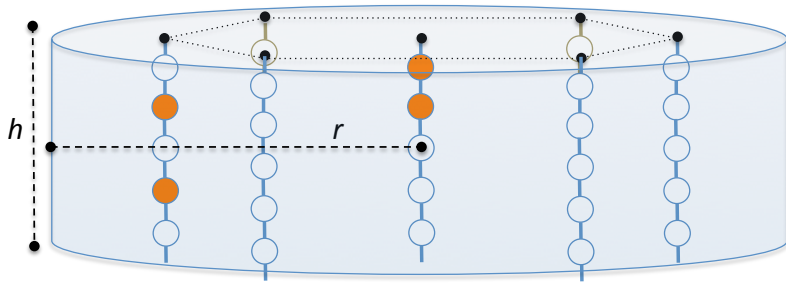

DAQ selects causal patterns of light (hits) from particle interactions

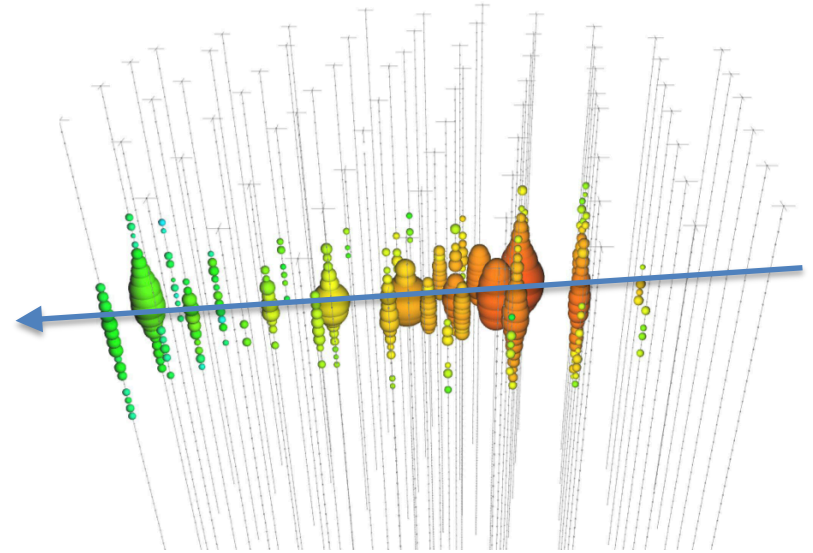

PnF performs fast reconstructions on those events, selects subsets interesting for analysis

# Hardware Maintenance and Pole Operations

# Inside the IceCube Lab (ICL)

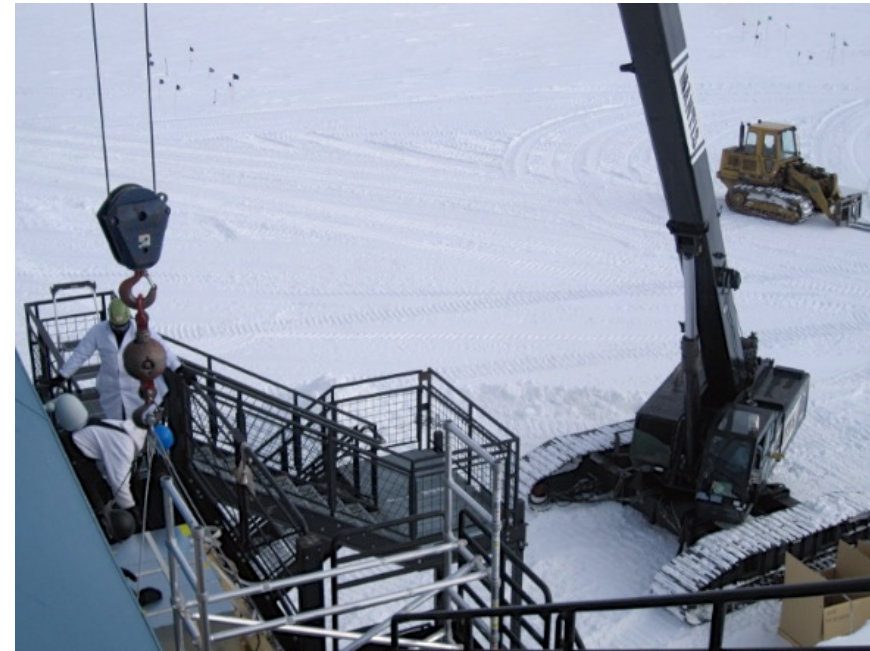

photo credit: F. Pedreros

- 18 racks of equipment
- 97 DOMHubs (1 / string + IceTop)
  - low-power single-board computers
  - custom DOM readout cards
  - DOM power supplies
- ~40 Dell PowerEdge servers
  - DAQ, PnF, infrastructure
- GPS receivers + fanouts, network switches, UPS, special devices

# Computing Maintenance

- Regular server replacements
  - life cycle extended from 4 (M&O plan) to 5 years
  - 100% replacement in 2013–14
  - 50% replacement in 2018–19 + 50% in 2019–20
- UPS battery replacements
- Standard security software patches



# Hardware Stability

Failures in this M&O period  
(from April 1, 2016)

Component	Failures
DOM power supplies (Acopian)	43
Hub power supplies	20
Hub memory	2
Hub hard drives	4
Hub single-board computers	1
DOM readout cards	0
Clock fanout cards	2
DOMs	3
master clock	1

- Custom electronics (including DOMs) highly reliable
- Hub hard drive failure rate being monitored
  - increase since March 2018
  - life cycle replacement planned 2019–20
- DOMHub power supply failure rate high in 2016
  - stabilized in 2017 to present (fewer hub power-cycles)
  - redundant, so failure has no impact on data-taking
- DOM power supply failure rate unacceptably high
  - full replacement 2016–17 pole season
  - failure rate stabilized but did not decrease



# DOM Power Supply



Mean Well MSP-200-48

- 16 strings running on new Mean Well power supplies since December 2017
- Additional 36 strings swapped in November 2018
- No failures yet; more stable than Acopians
- Full replacement planned for 2019–20 season

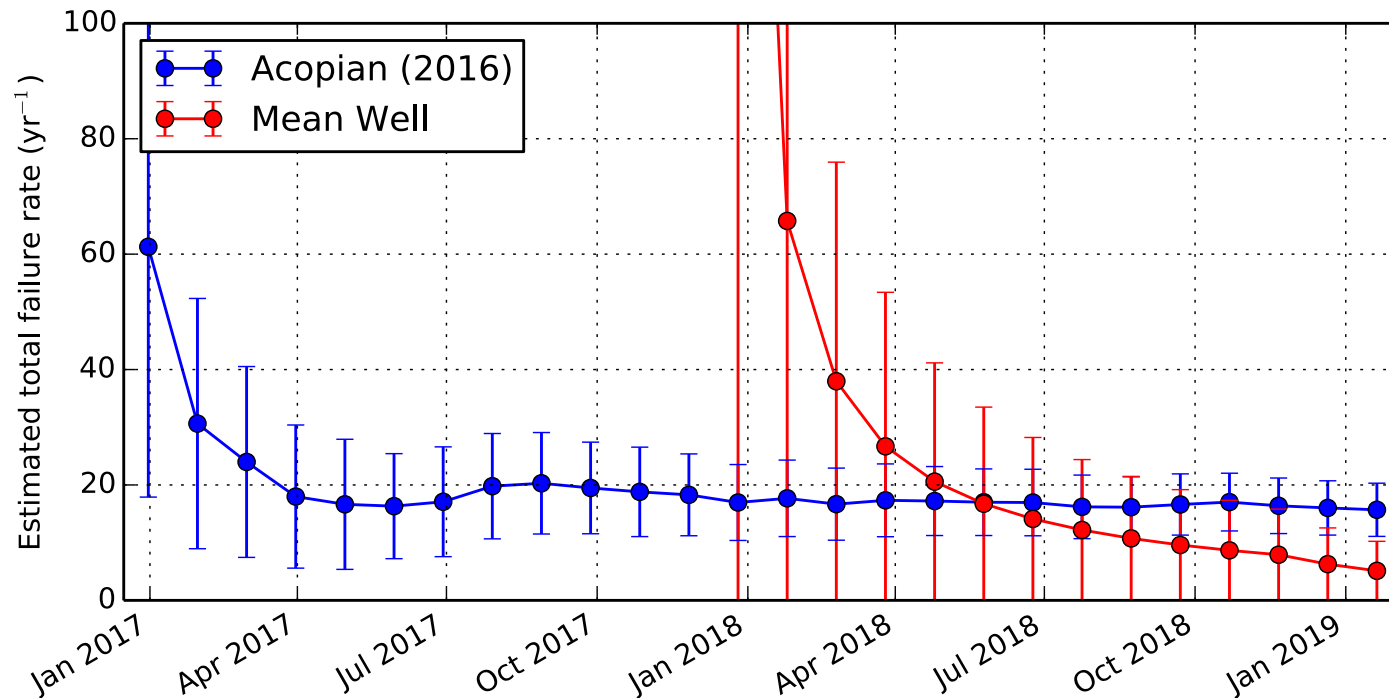

# Pole Operations

- Pole Operations: planning and execution of on-site M&O activities
  - on-site winterover training
  - computing and hardware maintenance
  - calibration activities (e.g. SPICEcore)
  - new instrumentation (e.g. scintillator prototypes)
- Population evaluated based on tasking and priorities
  - approx. 15 people / season
- Combination of expert personnel and student / postdoc first-timers
  - training at WIPAC when needed
- Logistics support from contractor managed by Jim Haugen



# Data Quality

### Data Acquisition

**131654** **RUNNING** 2h 09m  
Current run pDAQ rate Duration

Tyrarena4 20,829,441 dark  
pDAQ release Event count LID mode

Full Start 5409 / 5409  
Transition Active DOMs

sps-IC86-2018-tweak-Grilled-Cheese-V279  
Run configuration

### Live Alerts

- multirunfail
- runfail
- FPMaster disk usage too high
- PnF file backlog too large
- Too much time betw...DAQ latency messages
- Detector not taking data
- Excessive run failure rate
- I3DAQDispatch is not RUNNING
- I3MS link is not UP
- Lots of LBM overflows
- Modem ttyS1 is unable to connect
- Modem ttyS4 is unable to connect
- Modem ttyS5 is unable to connect
- Modem ttyS6 is unable to connect
- PFDSTWriter is not RUNNING
- PFFiltWriter is not RUNNING
- PFRawWriter is not RUNNING
- PFServer1 is not RUNNING
- PFServer2 is not RUNNING
- PFServer3 is not RUNNING
- PFServer4 is not RUNNING
- PFServer5 is not RUNNING
- PFServer6 is not RUNNING
- PFServer7 is not RUNNING
- PFServer8 is not RUNNING
- PnF latency too high
- PnF rate too low
- PPP link is not UP
- SERIOUS SN alert triggered!
- SNDAQ is not RUNNING
- SNDAQ latency too high
- Throttling messages from noisy service
- Too many \*.dat file...local/pdaq/sndaq/tmp
- Too many \*sn.tar fi.../mnt/data/pdaq/local
- Too many missing DOMs
- Too much time between...I3MS monitoring msgs
- Too much time between SNDAQ alerts

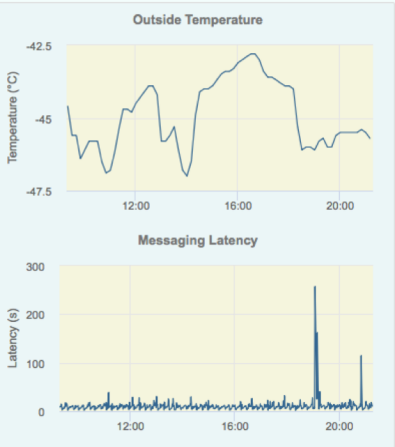
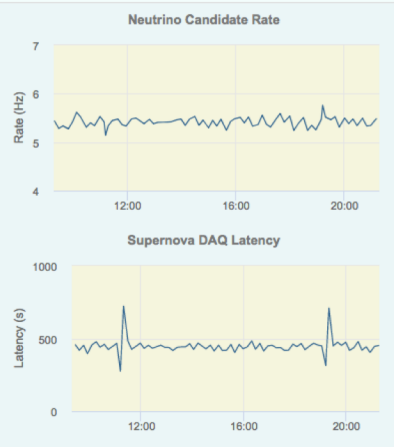
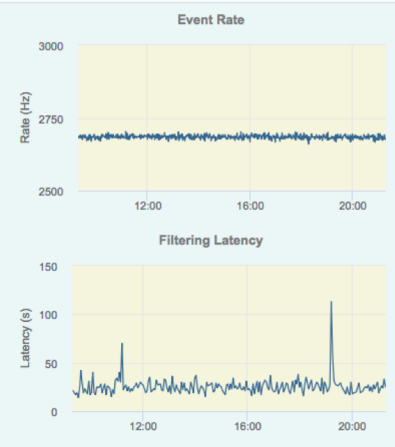

### Components

I3DAQDispatch <b>RUNNING</b>	PFDSTWriter <b>RUNNING</b>
PFFiltWriter <b>RUNNING</b>	PFMoniWriter1 <b>RUNNING</b>
PFMoniWriter2 <b>RUNNING</b>	PFMoniWriter3 <b>RUNNING</b>
PFMoniWriter4 <b>RUNNING</b>	PFOneWriter <b>RUNNING</b>
PFRawWriter <b>RUNNING</b>	PFServer1 <b>RUNNING</b>
PFServer2 <b>RUNNING</b>	PFServer3 <b>RUNNING</b>
PFServer4 <b>RUNNING</b>	PFServer5 <b>RUNNING</b>
PFServer6 <b>RUNNING</b>	PFServer7 <b>RUNNING</b>
PFServer8 <b>RUNNING</b>	sndaq <b>RUNNING</b>
uptimer <b>RUNNING</b>	

### Component Alerts

No alerts in past 24h

- PFFiltWriter 2d 5h 58m ago missing events
- I3DAQDispatch 12d 6h 39m ago missing or invalid run summary! waiting for a valid one...
- hubmoni 15d 23h 9m ago ichub29: unexpected number of DOMs
- hubmoni 15d 23h 15m ago (thub07: unexpected number of DOMs
- hubmoni 16d 2h 3m ago (thub08: unexpected number of DOMs
- hubmoni 17d 17h 52m ago (chub35: unexpected number of DOMs
- hubmoni 18d 2h 16m ago (chub29: unexpected number of DOMs
- PFServer server-crash 19d 8h 14m ago
- I3DAQDispatch 20d 10h 13m ago missing or invalid run summary! waiting for a valid one...
- hubmoni 21d 8h 29m ago (chub33: unexpected number of DOMs
- hubmoni 21d 8h 29m ago (chub33: DOM power check failure
- pdaq 22d 3h 7m ago Master Clock is out of agreement with the NTP reference

### Recent Log Msgs

```

2018-10-23 19:09:29 Watchdog reports starved components: stringHub#203->IceTopTrigger icetopBit.RecordsReceived not changing from [16261,
2018-10-23 19:07:33 Using system time for initial event counts (no event times available)
2018-10-23 19:07:15 Starting run 131654...
2018-10-23 19:07:14 Cluster: sps-cluster
2018-10-23 19:07:14 Run configuration: sps-IC86-2018-tweak-Grilled-Cheese-V279
2018-10-23 19:07:14 Version info: Tyrarena4 14222:143282 2018-08-10 20:20:07
2018-10-23 19:06:48 pdaq: STOPPED -> start {'runNumber': 131654, 'subRunNumber': 0, 'runConfig': 'u'sps-IC86-2018-tweak-Grilled-Cheese-V279
2018-10-23 19:06:32 Wrote combined log for run 131653
2018-10-23 19:06:31 Writing combined log for run 131653
2018-10-23 19:06:29 Run terminated SUCCESSFULLY.
2018-10-23 19:06:29 77380238 physics events collected in 28820 seconds (2684.95 Hz)
2018-10-23 19:06:23 pdaq: RUNNING -> stop
2018-10-23 19:05:35 Watchdog reports starved components: stringHub#210->IceTopTrigger icetopBit.RecordsReceived not changing from [1956673
2018-10-23 19:05:26 Watchdog reports hanging components: stringHub#84
2018-10-23 17:43:20 Watchdog reports starved components: stringHub#210->IceTopTrigger icetopBit.RecordsReceived not changing from [1873574
2018-10-23 16:54:30 Watchdog reports starved components: stringHub#210->IceTopTrigger icetopBit.RecordsReceived not changing from [1824024
2018-10-23 16:49:28 Watchdog reports starved components: stringHub#210->IceTopTrigger icetopBit.RecordsReceived not changing from [1818865
2018-10-23 16:47:46 Watchdog reports starved components: stringHub#210->IceTopTrigger icetopBit.RecordsReceived not changing from [1817186
2018-10-23 14:20:00 Watchdog reports starved components: stringHub#210->IceTopTrigger icetopBit.RecordsReceived not changing from [1667354
2018-10-23 13:36:22 Sending Alert 4.82454 (# 57 in run 131653 )
2018-10-23 13:35:18 Sending Alert 5.09722 (# 56 in run 131653 )
2018-10-23 13:33:37 Sending Alert 4.26094 (# 55 in run 131653 )
2018-10-23 13:31:20 Sending Alert 4.80873 (# 54 in run 131653 )
2018-10-23 13:27:18 Sending Alert 4.75233 (# 53 in run 131653 )
2018-10-23 13:25:23 Sending Alert 4.51294 (# 52 in run 131653 )
2018-10-23 13:23:07 Sending Alert 4.66859 (# 51 in run 131653 )
2018-10-23 13:21:23 Sending Alert 4.53084 (# 50 in run 131653 )
2018-10-23 13:19:24 Sending Alert 4.18529 (# 49 in run 131653 )
2018-10-23 13:17:21 Sending Alert 4.29741 (# 48 in run 131653 )
2018-10-23 13:13:18 Sending Alert 4.15197 (# 47 in run 131653 )
2018-10-23 13:11:22 Sending Alert 4.02718 (# 46 in run 131653 )
2018-10-23 13:11:10 Watchdog reports starved components: stringHub#210->IceTopTrigger icetopBit.RecordsReceived not changing from [1597214
2018-10-23 13:10:14 Sending Alert 4.16611 (# 45 in run 131653 )
2018-10-23 13:06:11 Sending Alert 4.44682 (# 44 in run 131653 )
    
```

# IceCube Live: experiment control, detector status, and data monitoring

### Data Acquisition

**131654** **RUNNING** 2h 09m  
Current run DAQ rate Duration

Tyrarena4 20,829,441 dark  
pDAQ release Event count LID mode

Full Start 5409 / 5409  
Transition Active DOMs

sps-IC86-2018-tweak-Grilled-Cheese-V279  
Run configuration

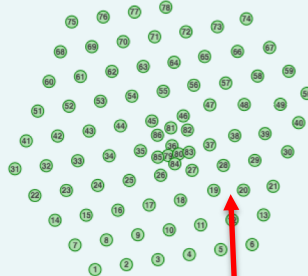

### Components

I3DAQDispatch <b>RUNNING</b>	PFDSTWriter <b>RUNNING</b>
PFFiltWriter <b>RUNNING</b>	PFMonWriter1 <b>RUNNING</b>
PFMoniWriter2 <b>RUNNING</b>	PFMonWriter3 <b>RUNNING</b>
PFMoniWriter4 <b>RUNNING</b>	PFOneWriter <b>RUNNING</b>
PFRawWriter <b>RUNNING</b>	PFServer1 <b>RUNNING</b>
PFServer2 <b>RUNNING</b>	PFServer3 <b>RUNNING</b>
PFServer4 <b>RUNNING</b>	PFServer5 <b>RUNNING</b>
PFServer6 <b>RUNNING</b>	PFServer7 <b>RUNNING</b>
PFServer8 <b>RUNNING</b>	snDAQ <b>RUNNING</b>
uptimer <b>RUNNING</b>	

### Live Alerts

- multirunfail
- runfail
- FPMaster disk usage too high
- PnF file backlog too large
- Too much time betw...DAQ latency messages
- Detector not taking data
- Excessive run failure rate
- I3DAQDispatch is not RUNNING
- I3MS link is not UP
- Lots of LBM overflows
- Modem ttyS1 is unable to connect
- Modem ttyS4 is unable to connect
- Modem ttyS5 is unable to connect
- Modem ttyS6 is unable to connect
- PFDSTWriter is not RUNNING
- PFFiltWriter is not RUNNING
- PFRawWriter is not RUNNING
- PFServer1 is not RUNNING
- PFServer2 is not RUNNING
- PFServer3 is not RUNNING
- PFServer4 is not RUNNING
- PFServer5 is not RUNNING
- PFServer6 is not RUNNING
- PFServer7 is not RUNNING
- PFServer8 is not RUNNING
- PnF latency too high
- PnF rate too low
- PPP link is not UP
- SERIOUS SN alert triggered!
- SNDAQ is not RUNNING
- SNDAQ latency too high
- Throttling messages from noisy service
- Too many \*.dat file...local/pdaq/snDAQ/tmp
- Too many \*sn.tar fil.../mnt/data/pdaq/local
- Too many missing DOMs
- Too much time between...I3MS monitoring msgs
- Too much time between SNDAQ alerts

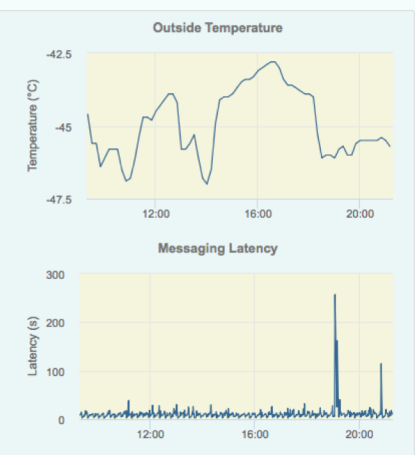
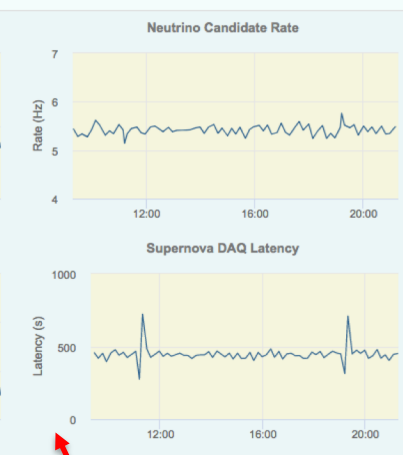
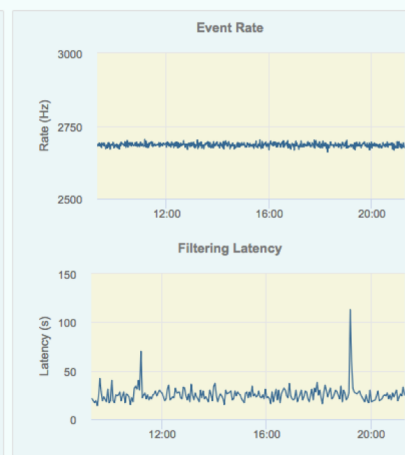

### Component Alerts

No alerts in past 24h

- PFFiltWriter 2d 5h 58m ago missing events
- I3DAQDispatch 12d 6h 39m ago missing or invalid run summary! waiting for a valid one...
- hubmoni 15d 23h 9m ago ichub29: unexpected number of DOMs
- hubmoni 15d 23h 15m ago ihub07: unexpected number of DOMs
- hubmoni 16d 2h 3m ago ihub08: unexpected number of DOMs
- hubmoni 17d 17h 52m ago ichub35: unexpected number of DOMs
- hubmoni 18d 2h 16m ago ichub29: unexpected number of DOMs
- PFServer server-crash 19d 8h 14m ago
- I3DAQDispatch 20d 10h 13m ago missing or invalid run summary! waiting for a valid one...
- hubmoni 21d 8h 29m ago ichub33: unexpected number of DOMs
- hubmoni 21d 8h 29m ago ichub33: DOM power check failure
- pdaq 22d 3h 7m ago Master Clock is out of agreement with the NTP reference

### Recent Log Msgs

```

2018-10-23 19:09:28 Watchdog reports starved components: stringHub#203->IceTopTrigger icetopBit.RecordsReceived not changing from [16261,
2018-10-23 19:07:33 Using system time for initial event counts (no event times available)
2018-10-23 19:07:15 Starting run 131654...
2018-10-23 19:07:14 Cluster: sps-cluster
2018-10-23 19:07:14 Run configuration: sps-IC86-2018-tweak-Grilled-Cheese-V279
2018-10-23 19:07:14 Version info: Tyrarena4 14222;143282 2018-08-10 20:20:07
2018-10-23 19:06:48 pdaq STOPPED -> start {'runNumber': 131654, 'subRunNumber': 0, 'runConfig': 'u'sps-IC86-2018-tweak-Grilled-Cheese-V279
2018-10-23 19:06:32 Wrote combined log for run 131653
2018-10-23 19:06:31 Writing combined log for run 131653
2018-10-23 19:06:29 Run terminated SUCCESSFULLY.
2018-10-23 19:06:29 77380238 physics events collected in 28820 seconds (2684.95 Hz)
2018-10-23 19:06:23 pdaq RUNNING -> stop
2018-10-23 19:05:35 Watchdog reports starved components: stringHub#210->IceTopTrigger icetopBit.RecordsReceived not changing from [1956673
2018-10-23 19:05:26 Watchdog reports hanging components: stringHub#4
2018-10-23 17:43:20 Watchdog reports starved components: stringHub#210->IceTopTrigger icetopBit.RecordsReceived not changing from [1873574
2018-10-23 16:54:30 Watchdog reports starved components: stringHub#210->IceTopTrigger icetopBit.RecordsReceived not changing from [1824024
2018-10-23 16:49:28 Watchdog reports starved components: stringHub#210->IceTopTrigger icetopBit.RecordsReceived not changing from [1818865
2018-10-23 16:47:46 Watchdog reports starved components: stringHub#210->IceTopTrigger icetopBit.RecordsReceived not changing from [1817186
2018-10-23 14:20:00 Watchdog reports starved components: stringHub#210->IceTopTrigger icetopBit.RecordsReceived not changing from [1667354
2018-10-23 13:36:22 Sending Alert 4.8245 (# 57 in run 131653 )
2018-10-23 13:35:18 Sending Alert 5.09722 (# 56 in run 131653 )
2018-10-23 13:33:37 Sending Alert 4.26094 (# 55 in run 131653 )
2018-10-23 13:31:20 Sending Alert 4.80873 (# 54 in run 131653 )
2018-10-23 13:27:18 Sending Alert 4.75233 (# 53 in run 131653 )
2018-10-23 13:25:23 Sending Alert 4.51294 (# 52 in run 131653 )
2018-10-23 13:23:07 Sending Alert 4.66859 (# 51 in run 131653 )
2018-10-23 13:21:23 Sending Alert 4.53064 (# 50 in run 131653 )
2018-10-23 13:19:24 Sending Alert 4.18529 (# 49 in run 131653 )
2018-10-23 13:17:21 Sending Alert 4.29741 (# 48 in run 131653 )
2018-10-23 13:13:18 Sending Alert 4.15197 (# 47 in run 131653 )
2018-10-23 13:11:22 Sending Alert 4.02718 (# 46 in run 131653 )
2018-10-23 13:11:10 Watchdog reports starved components: stringHub#210->IceTopTrigger icetopBit.RecordsReceived not changing from [1597214
2018-10-23 13:10:14 Sending Alert 4.16611 (# 45 in run 131653 )
2018-10-23 13:06:11 Sending Alert 4.44682 (# 44 in run 131653 )
    
```

real-time run + detector overview (via Iridium)

alert status and history (serious alerts page winterovers)

detector summary plots & log messages

# IceCube Live Good Run List

Run	Started	Duration	Rate	Drop	Configuration	DAQ release	LID	Trans	PnF	Moni	Shift	InIce	IceTop	Comments
131930	2018-12-17 14:30:19	in progress	-	-	sps-IC86-2018-tw...lled-Cheese-V279	Urban_Harvest2	dark	FS	PP	-	wait	BAD	BAD	±
131929	2018-12-17 06:28:50	8:00:12	2907.92	-	sps-IC86-2018-tw...lled-Cheese-V279	Urban_Harvest2	dark	SR	PP	☆☆☆☆☆	wait	GOOD	GOOD	±
131928	2018-12-16 22:28:36	8:00:14	2905.18	-	sps-IC86-2018-tw...lled-Cheese-V279	Urban_Harvest2	dark	SR	PP	★★★★★	dpankova	GOOD	GOOD	±
131927	2018-12-16 14:28:19	8:00:17	2902.15	-	sps-IC86-2018-tw...lled-Cheese-V279	Urban_Harvest2	dark	SR	PP	★★★★★	dpankova	GOOD	GOOD	±
131926	2018-12-16 06:28:15	8:00:04	2899.41	-	sps-IC86-2018-tw...lled-Cheese-V279	Urban_Harvest2	dark	FS	PP	★★★★★	jdelaunay	GOOD	GOOD	±
131925	2018-12-15 22:26:49	8:00:18	2898.06	-	sps-IC86-2018-tw...lled-Cheese-V279	Urban_Harvest2	dark	SR	PP	★★★★★	jdelaunay	GOOD	GOOD	PnF crash restarted PnF Issues with PFMoniWrit... ±
131924	2018-12-15 14:26:33	8:00:16	2899.37	-	sps-IC86-2018-tw...lled-Cheese-V279	Urban_Harvest2	dark	SR	PP	★★★★★	jdelaunay	GOOD	GOOD	±
131923	2018-12-15 06:26:24	8:00:09	2901.57	-	sps-IC86-2018-tw...lled-Cheese-V279	Urban_Harvest2	dark	SR	PP	★★★★★	jdelaunay	GOOD	GOOD	±
131922	2018-12-14 22:26:22	8:00:02	2901.82	-	sps-IC86-2018-tw...lled-Cheese-V279	Urban_Harvest2	dark	FS	PP	★★★★★	jdelaunay	GOOD	GOOD	±
131921	2018-12-14 14:25:04	8:00:11	2902.45	-	sps-IC86-2018-tw...lled-Cheese-V279	Urban_Harvest2	dark	SR	PP	★★★★★	jdelaunay	GOOD	GOOD	±
131920	2018-12-14 06:24:49	8:00:15	2903.32	-	sps-IC86-2018-tw...lled-Cheese-V279	Urban_Harvest2	dark	SR	PP	★★★★★	jdelaunay	GOOD	GOOD	±
131919	2018-12-13 22:24:33	8:00:16	2905.22	-	sps-IC86-2018-tw...lled-Cheese-V279	Urban_Harvest2	dark	SR	PP	★★★★★	jdelaunay	GOOD	GOOD	±
131918	2018-12-13 14:24:31	8:00:02	2906.58	-	sps-IC86-2018-tw...lled-Cheese-V279	Urban_Harvest2	dark	FS	PP	★★★★★	jdelaunay	GOOD	GOOD	fplave07 crashed ±
131917	2018-12-13 06:23:16	8:00:10	2907.27	-	sps-IC86-2018-tw...lled-Cheese-V279	Urban_Harvest2	dark	SR	PP	★★★★★	jdelaunay	GOOD	GOOD	±
131916	2018-12-12 22:23:00	8:00:16	2908.08	-	sps-IC86-2018-tw...lled-Cheese-V279	Urban_Harvest2	dark	SR	PP	★★★★★	jdelaunay	GOOD	GOOD	±
131915	2018-12-12 14:22:48	8:00:12	2909.69	-	sps-IC86-2018-tw...lled-Cheese-V279	Urban_Harvest2	dark	SR	PP	★★★★★	jdelaunay	GOOD	GOOD	±
131914	2018-12-12 06:22:45	8:00:03	2912.45	-	sps-IC86-2018-tw...lled-Cheese-V279	Urban_Harvest2	dark	FS	PP	★★★★★	jdelaunay	GOOD	GOOD	±
131913	2018-12-11 22:21:14	8:00:11	2913.55	2	sps-IC86-2018-tw...lled-Cheese-V279	Urban_Harvest2	dark	SR	PP	★★★★★	jdelaunay	GOOD	GOOD	±
131912	2018-12-11 14:20:58	8:00:16	2913.07	2	sps-IC86-2018-tw...lled-Cheese-V279	Urban_Harvest2	dark	SR	PP	★★★★★	jdelaunay	GOOD	GOOD	±
131911	2018-12-11 06:20:44	8:00:14	2915.98	2	sps-IC86-2018-tw...lled-Cheese-V279	Urban_Harvest2	dark	SR	PP	★★★★★	jdelaunay	GOOD	GOOD	±
131910	2018-12-10 22:20:41	8:00:03	2919.95	-	sps-IC86-2018-tw...lled-Cheese-V279	Urban_Harvest2	dark	FS	PP	★★★★★	jdelaunay	GOOD	GOOD	±
131909	2018-12-10 22:07:22	0:12:19	2923.43	-	sps-IC86-2018-tw...lled-Cheese-V279	Urban_Harvest2	dark	FS	PP	★★★★★	jdelaunay	GOOD	GOOD	baseline settling run ±
131908	2018-12-10 20:41:28	1:24:12	2863.61	-	sps-IC86-2018-tw...e-V279-no01-no22	Urban_Harvest2	dark	FS	PP	★★★★★	mkauer	GOOD	GOOD	blessed ARA pulsing on 01 and 22 manually set to physic... partial 13 ±

- Central database of run quality information
- Interfaces for both humans and software

# IceCube Live Moni 2.0

Charge distribution collected for all DOMs in PnF

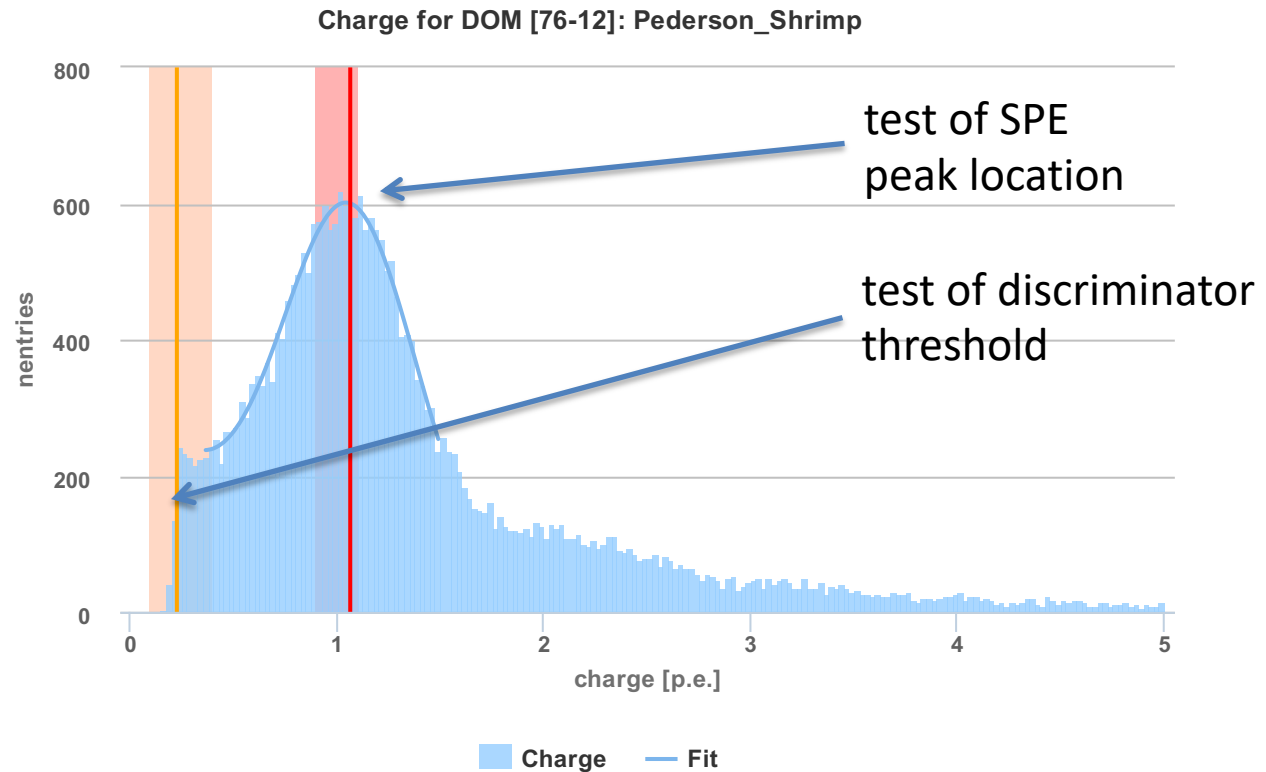

- Rewrite of data monitoring system released in 2017
- Monitoring data collected from subsystems and analyzed
- Improved accuracy, maintainability, and expandability compared to old system

# Additional Operational Upgrades



# GCD Server

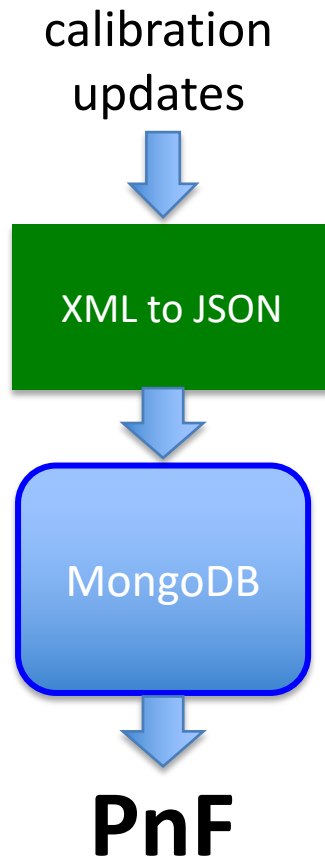

- Rewrite of Geometry / Calibration / Detector status (GCD) metadata framework
  - legacy system difficult to maintain / expand
- New database is very flexible
- Deployed May 2017 for physics run start
  - PnF, offline data processing updated to use new system

# Master Clock Upgrade

- Issues with legacy Symmetricom ET6000
  - buggy, unsupported firmware
  - potentially severe issues after [April 2019 GPS week rollover](#)
  - instability with one unit at pole

ET6000 after erroneous leap second



- Identified replacement: Spectracom SecureSync
  - running at pole as White Rabbit master clock since December 2017
  - validation at South Pole Test System in summer 2018
  - final testing at South Pole underway

Spectracom SecureSync 1200



# External Hitspool Alerts

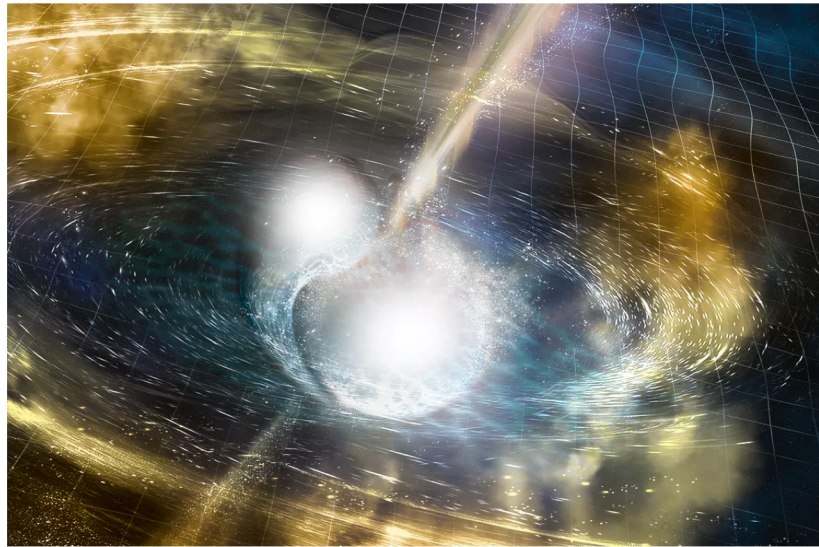

binary neutron star merger  
(artist's conception)

- Receive external multi-messenger alerts for gravitational wave (LIGO/VIRGO) and supernova (SNEWS) event
- Automatically save hitspool data for subthreshold analyses
  - archive to disk and/or transfer via satellite
- Will be active March 2019
  - in time for LIGO O3 run

# DAQ Improvements

## Integration of IceCube + IceCube Upgrade

**modified** IceCube  
DAQ software components

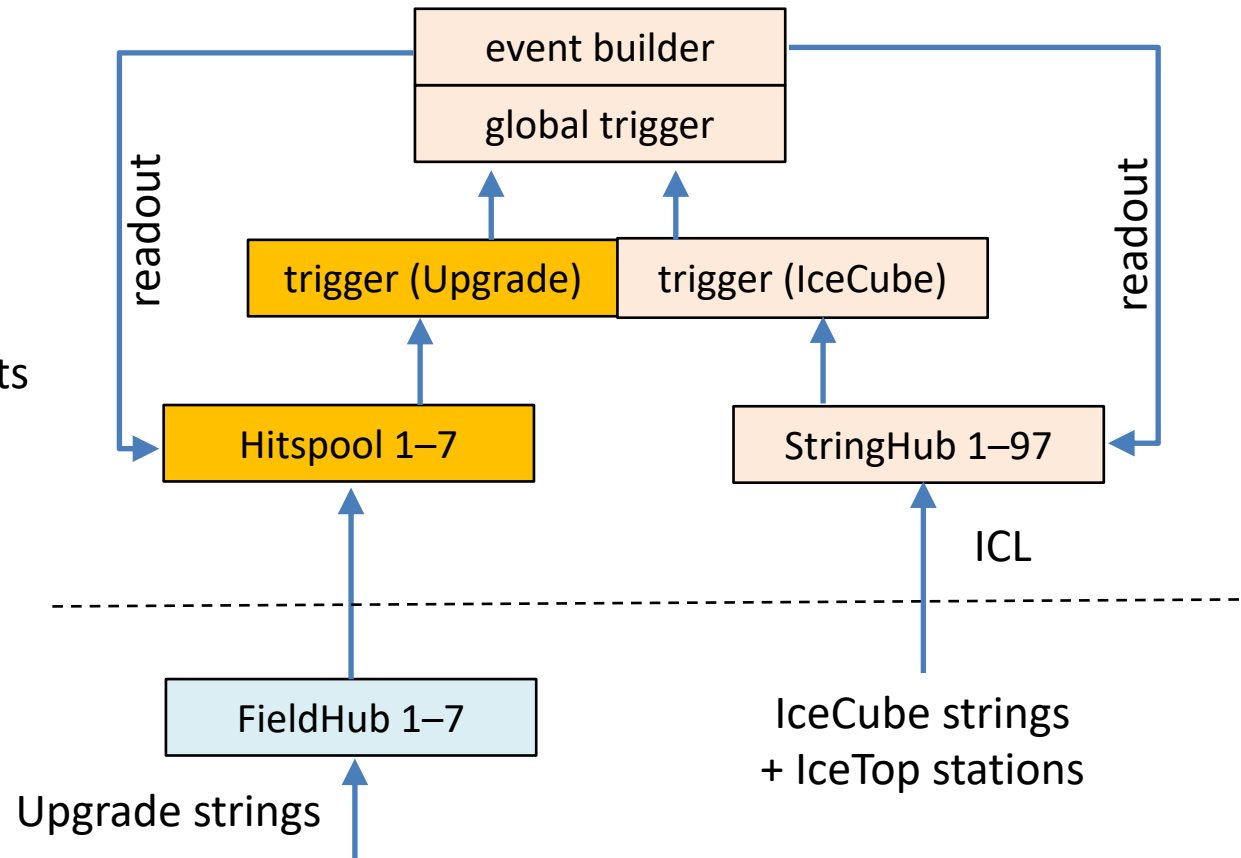

- Decouple DOM readout and hitspool / trigger
- Support expansion of detector (scintillator, Upgrade, and beyond)

# IceCube Upgrade and Beyond

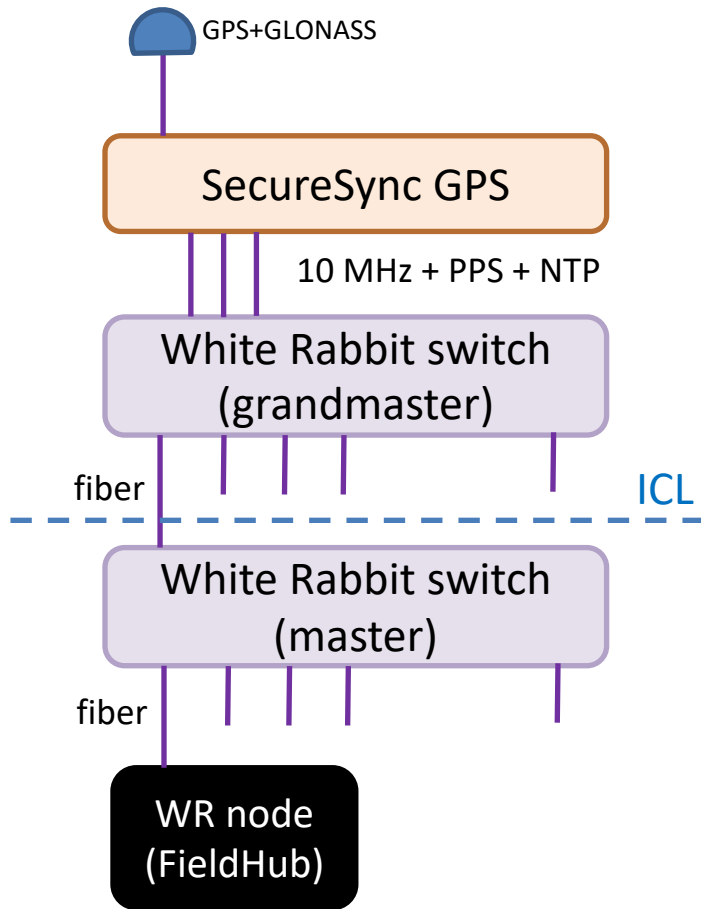

all elements synchronized  
to TAI +/- 1ns

- Scintillator installation validates Upgrade technical strategies
  - White Rabbit precision timing over optical fiber
  - moving DOMHubs out of ICL
- Legacy software retooled to be more expandable and maintainable
  - Moni2.0, GCD Server
- DAQ software improvements lay the groundwork for expansion

# Thank you!



J. Werthebach / NSF

# Realtime Event Page

## IceCube Realtime **BETA**

### Latest Events

#### neutrino

2018-12-17 20:45:39.738  
8 minutes ago

#### EHE

2018-10-23 16:37:32.652  
2 months ago

#### ESTRES

2018-12-17 19:29:14.102  
an hour ago

#### HESE

2018-12-17 20:19:24.760  
35 minutes ago

Run	Evt #	Event Time	Streams
131930	60936106	2018-12-17 20:19:24.760436	HESE
131930	52178458	2018-12-17 19:29:14.102660	ESTRES
131930	27948805	2018-12-17 17:10:26.587923	HESE
131930	13414151	2018-12-17 15:47:08.813584	ESTRES
131930	8760113	2018-12-17 15:20:29.672987	ESTRES
131930	693711	2018-12-17 14:34:17.122959	ESTRES
131929	75762014	2018-12-17 13:43:04.857337	ESTRES
131929	75242460	2018-12-17 13:40:06.471208	ESTRES
131929	70800470	2018-12-17 13:14:38.555655	HESE
131929	56913754	2018-12-17 11:55:04.679999	HESE

- Beta release in 2018; production in 2019
- Support continued expansion of multi-messenger program

# IceCube Messaging System (I3MS)



- I3MS messaging software supports all IceCube real-time data transfer to/from pole
  - detector status to IceCube Live
  - real-time alerts and event data
  - operations chat
- Dedicated bank of Iridium modems in IceCube Lab