

Detector Calibration

Dawn Williams
University of Alabama
IceCube Calibration WG Co-
Convenor

NSF Mid-Term Review
29th April 2024



Presenter Background

- Professor in the Department of Physics and Astronomy at the University of Alabama
- Member of IceCube Collaboration since 2004
- Extensive experience with IceCube flasher LED calibration system
- Co-convenor of the IceCube Calibration Working Group 2012-2017 and 2022-present (along with Andrii Terliuk, TU Munich)
- Analysis Coordinator 2017 - 2019
- Level 2 Lead for Calibration and Characterization for the IceCube Upgrade 2018-present
- Level 2 Lead for Calibration and Commissioning for IceCube-Gen2

Outline

- Standard calibrations
- DOM characterization
- Detector geometry
- Progress on the ice model
- Plans for the IceCube Upgrade

Calibration: from photon to data

Light source

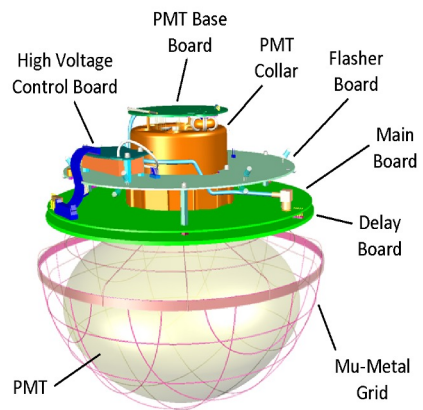
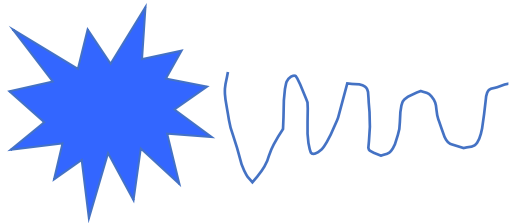

Propagation through ice

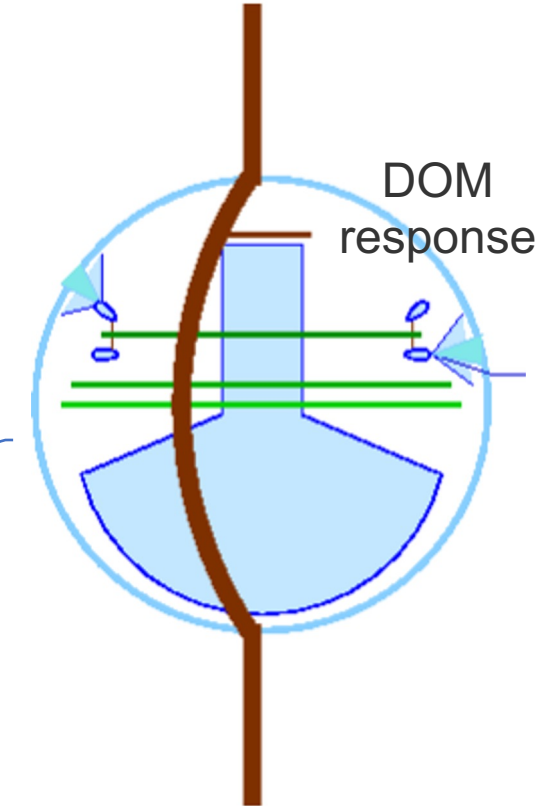
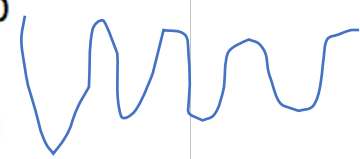
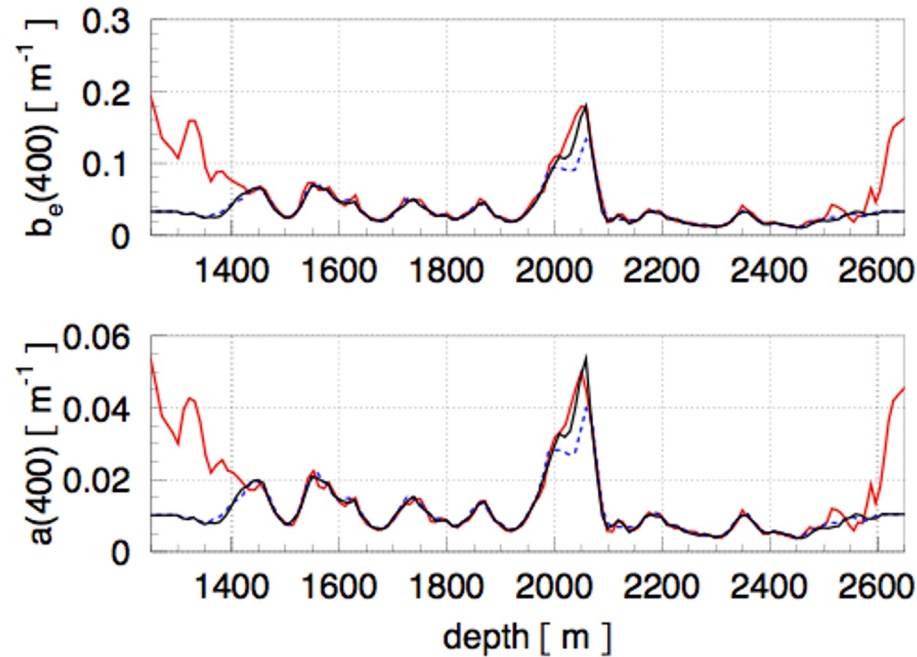

Characterizing the whole detector: instrumentation and ice
 Primary calibration light source is LED flashers in each DOM

Standard DOM calibration

- Routine calibration: DOMCal
 - Calibrates front end electronics, PMT gain and transit time
- IceTop DOMs calibrated monthly
- InIce DOMs calibrated annually

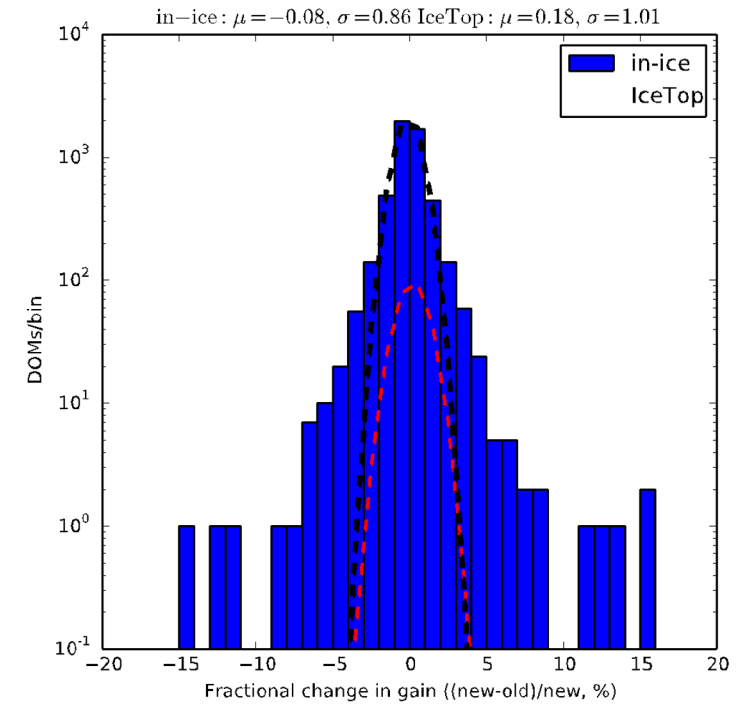

Performance Metric	Objective	Achieved	Description
DOM gain drift	< 2%	0.8%	Relative module gain change over time (95% quantile)
DOM timing stability	< 2.0 ns	1.8 ns	Spread in DOM timing calibration over time (95% quantile)
DOMCal result latency	< 1 week	< 4 days	Time to validate calibration results for online use



Single Photoelectron Calibration

Characterization of the SPE distribution on a per-DOM basis to improve data/MC agreement

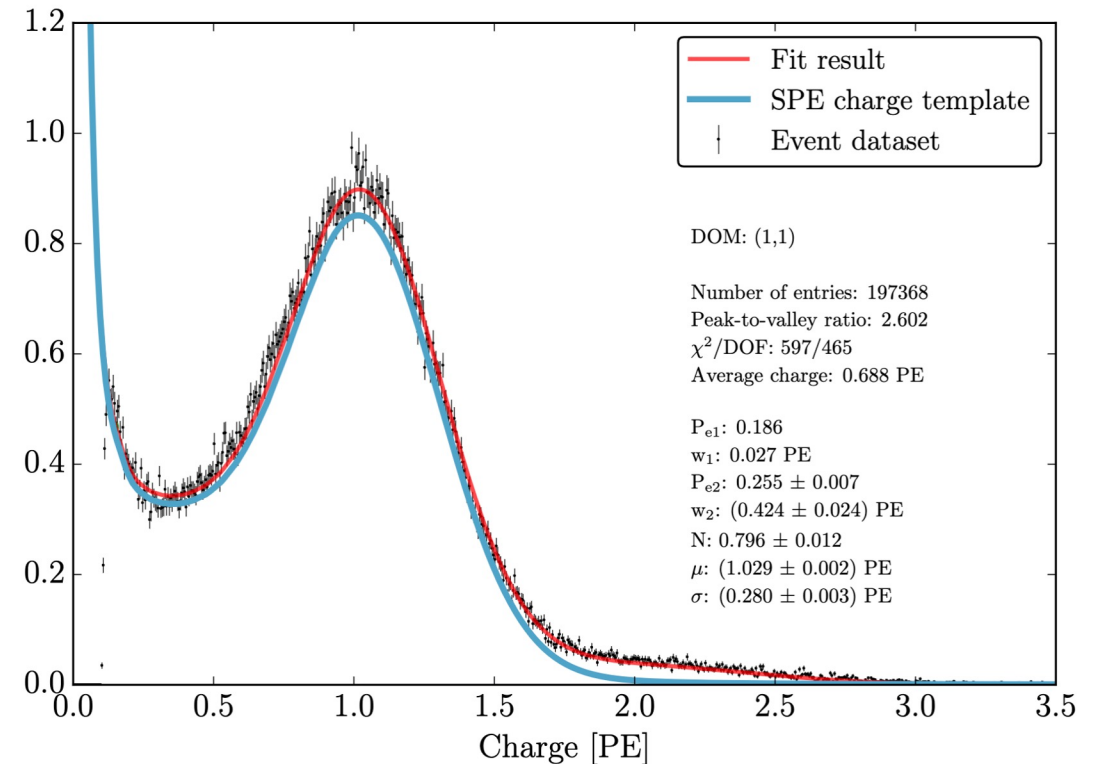
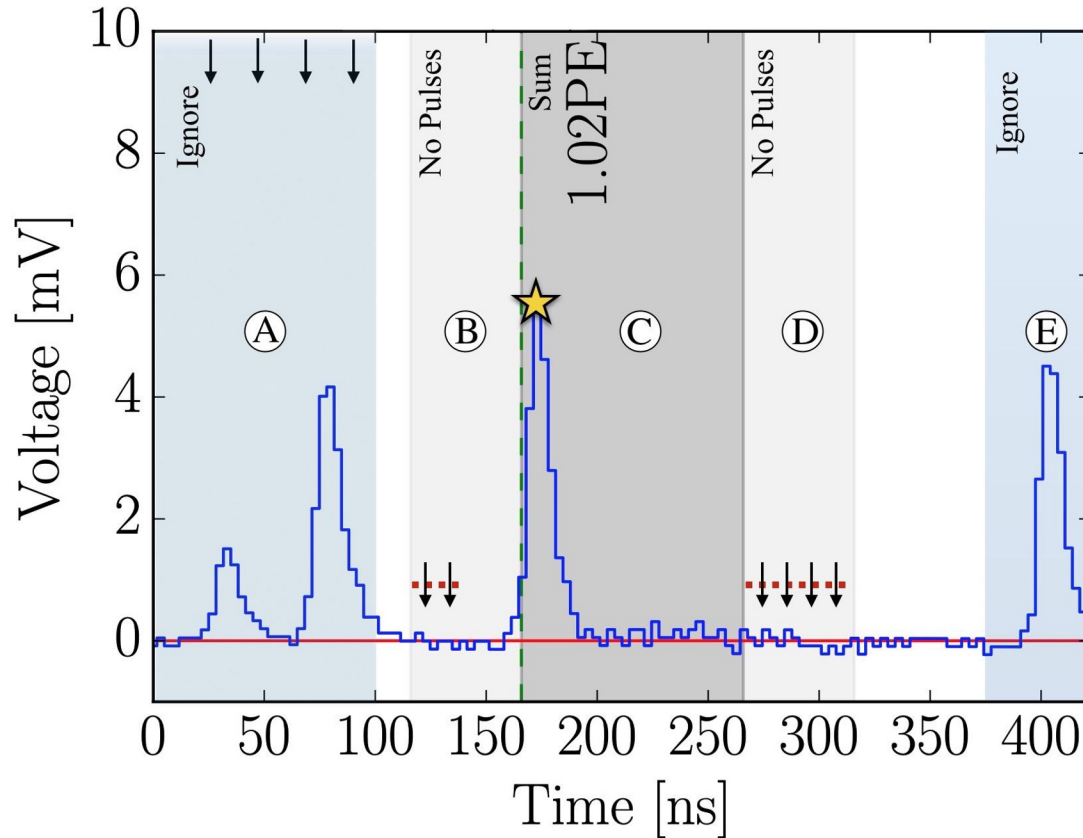

Pulse selection designed to minimize multiple PE contamination, avoid late pulses and afterpulses: resulting distribution fitted for each DOM, method published in JINST 15 (2020) 06, P06032

Currently fit is being updated with improved treatment of pulses from FADC waveforms, will be used in Pass 3 data processing

Geometry: lateral positions

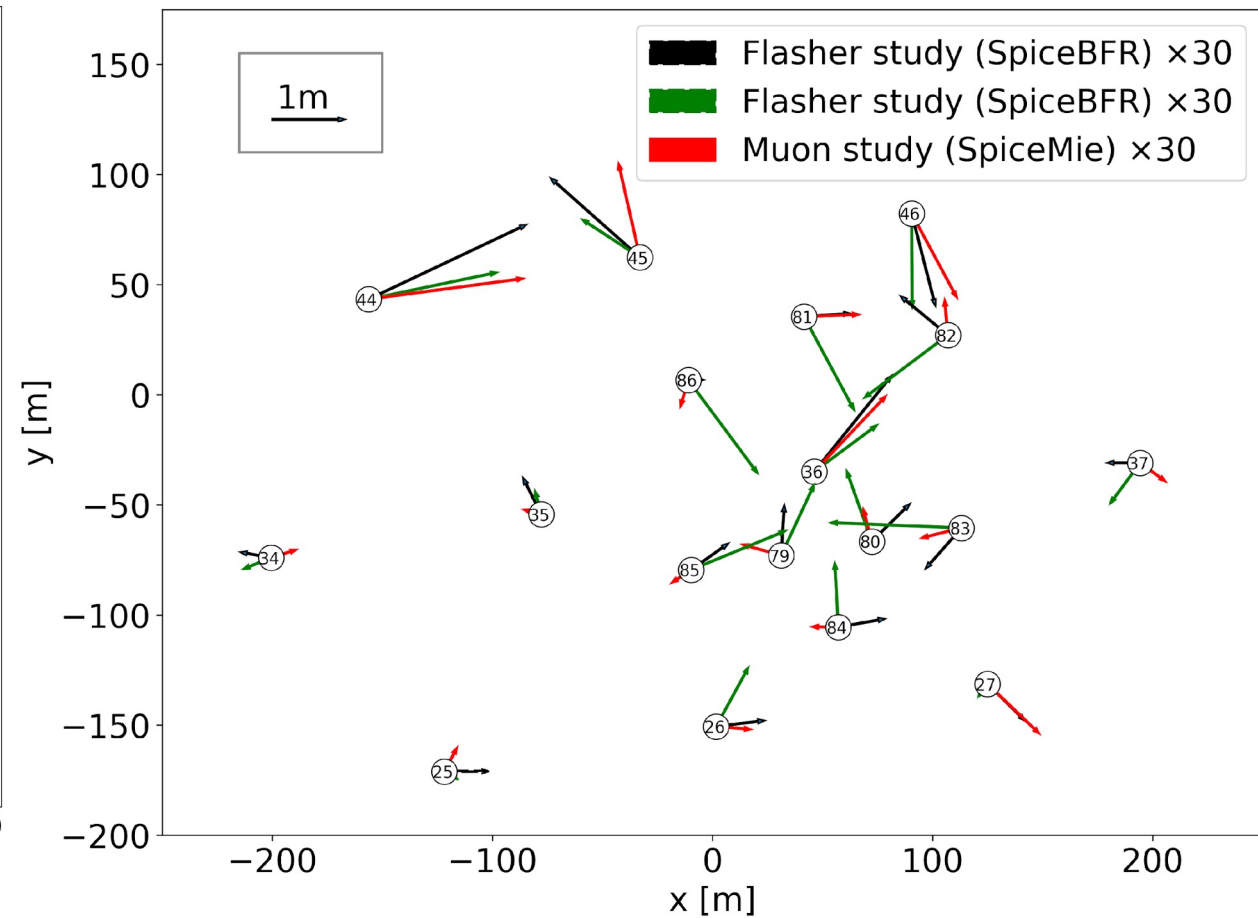
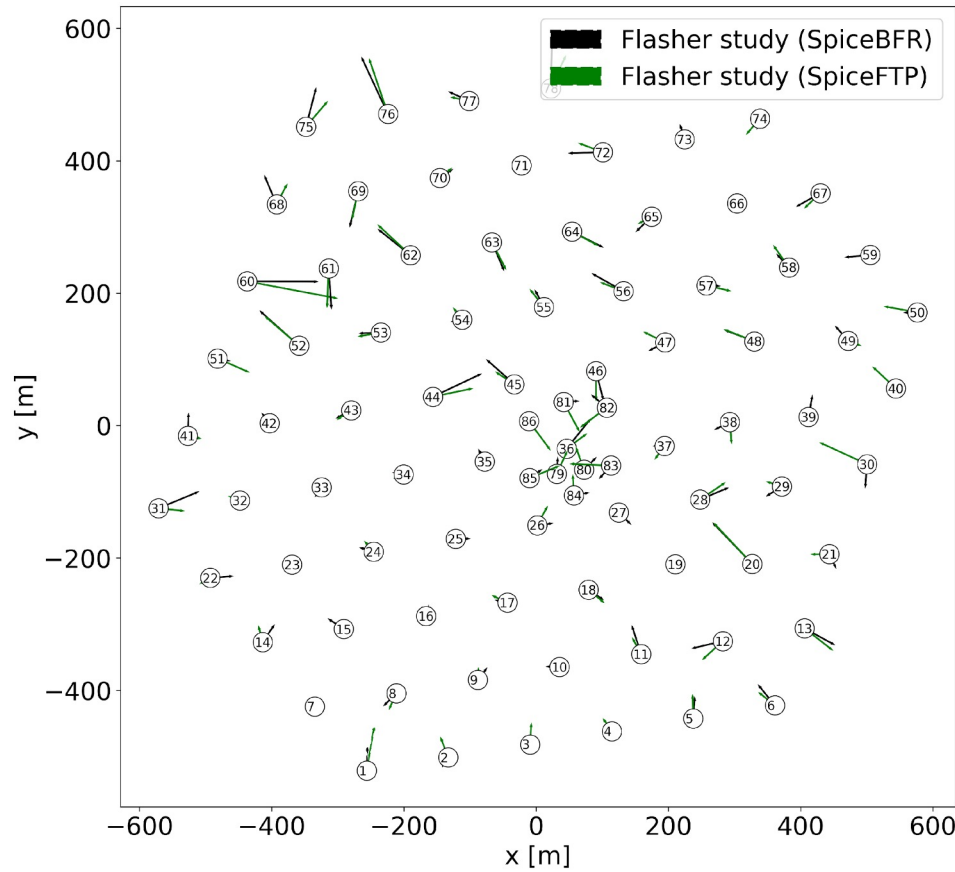

Geometry corrections to x-y positions of strings have been measured with good consistency between muons and flashers and between different ice models, impact on physics sensitivity being evaluated, shown at ICRC 2023

The ice model

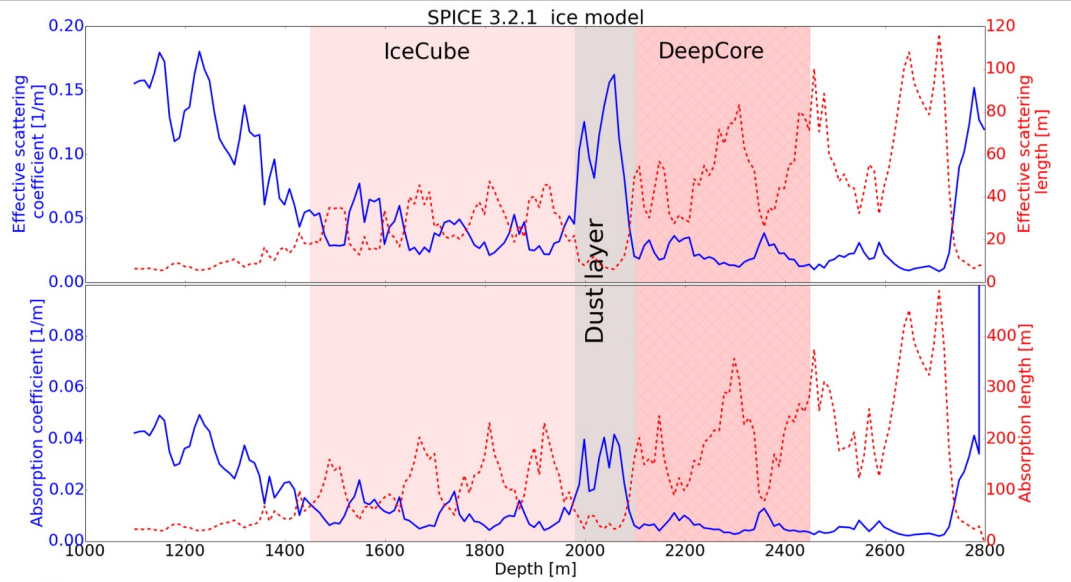

Depth dependent concentration of dust in undisturbed “bulk ice”

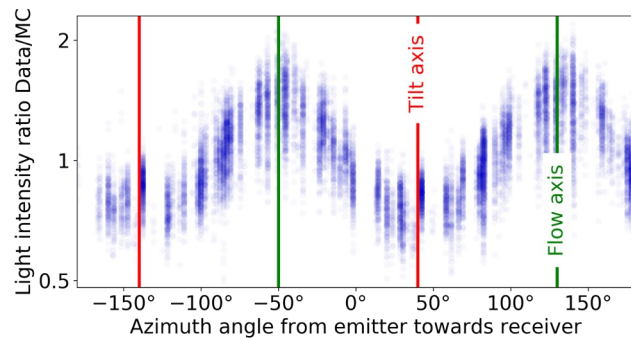

Anisotropy observed in brightness from flashers and muons

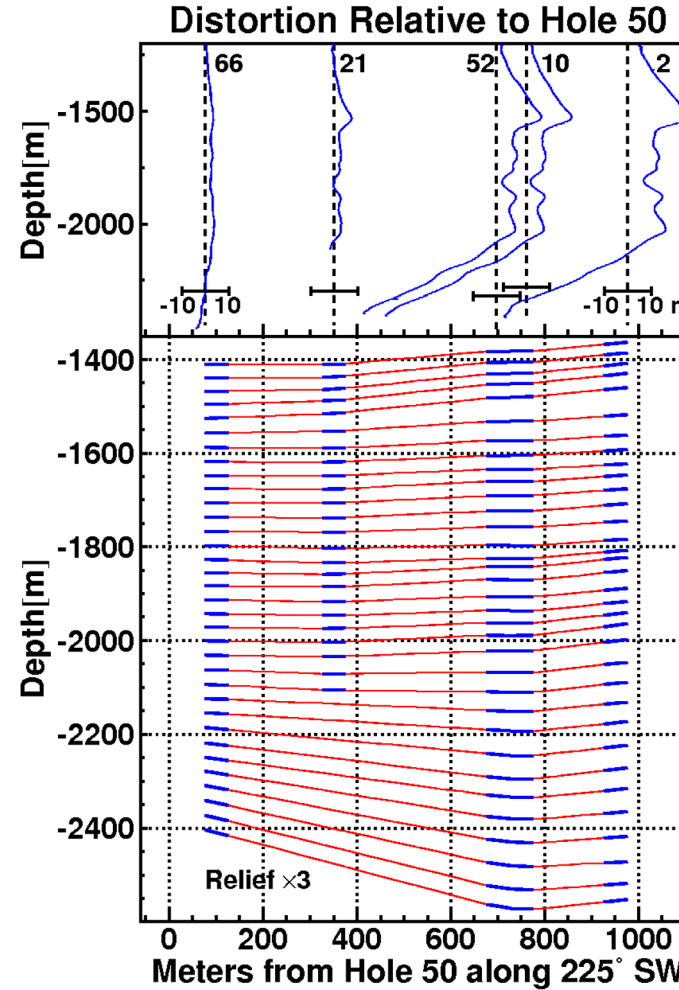

Dust layers not horizontal



Bubbles in refrozen “hole ice”

Birefringence

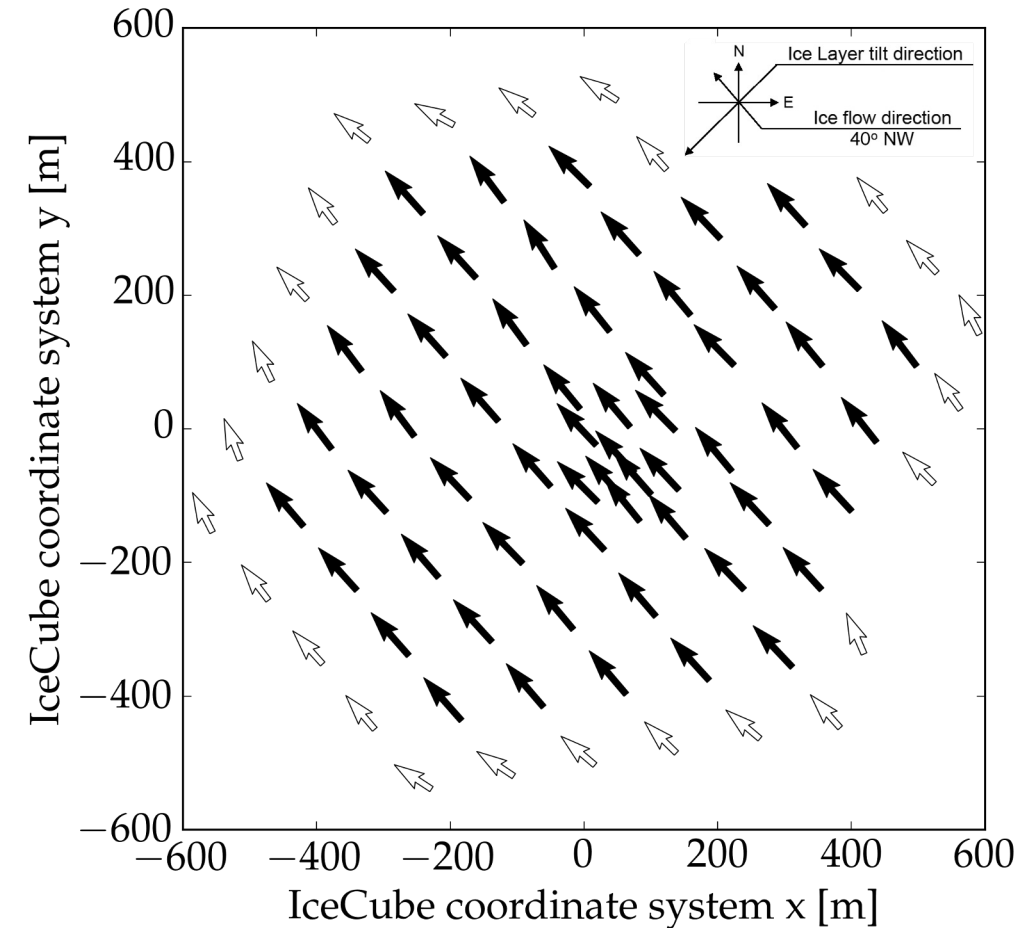
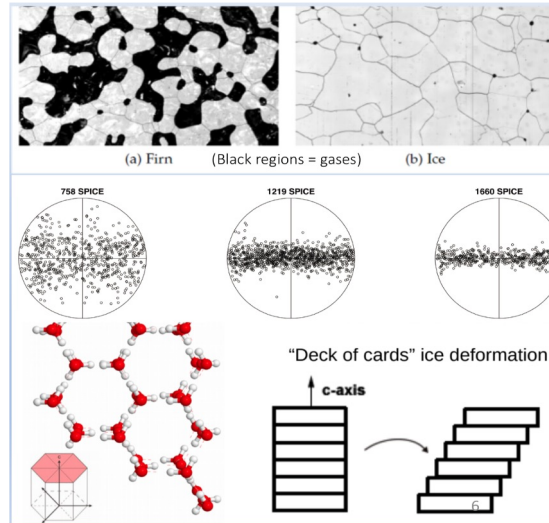
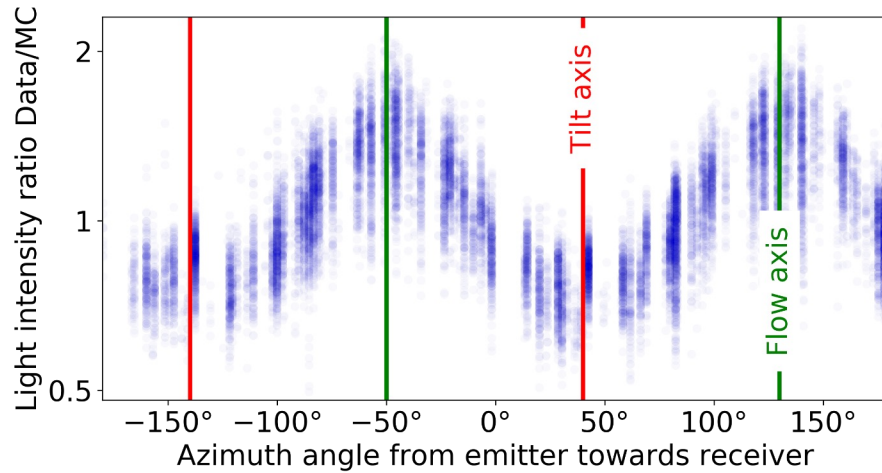

Continued refraction and reflection on boundaries of birefringent crystals leads to diffusion which is largest along the flow and a small deflection towards the flow axis, as well as an average deflection towards the flow axis, explaining the anisotropy

Diffusion & deflection given by average crystal size & shape

Birefringence

IceCube Coll., The Cryosphere, Volume 18, Issue 1, 2024

after ~ 1 m of propagation:

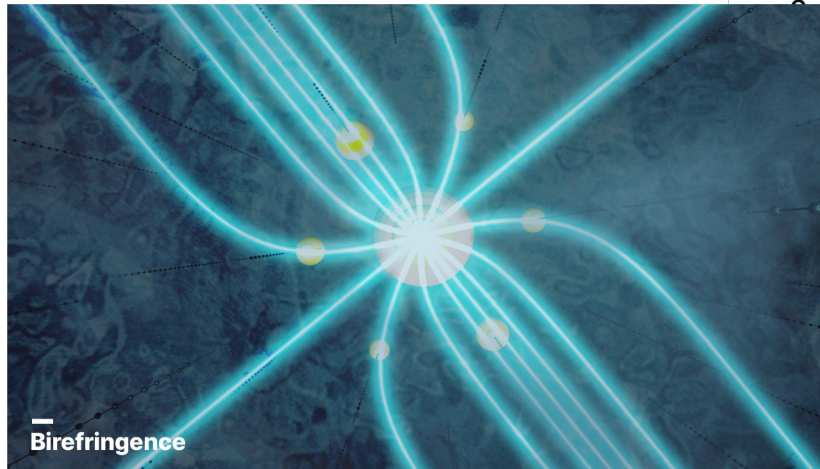

45 degrees to flow

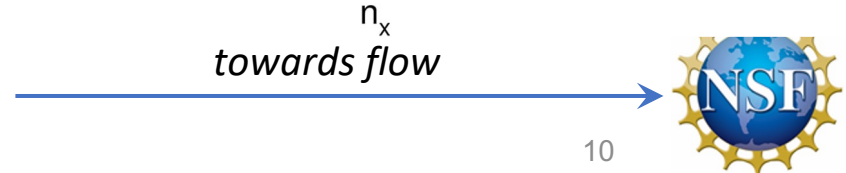
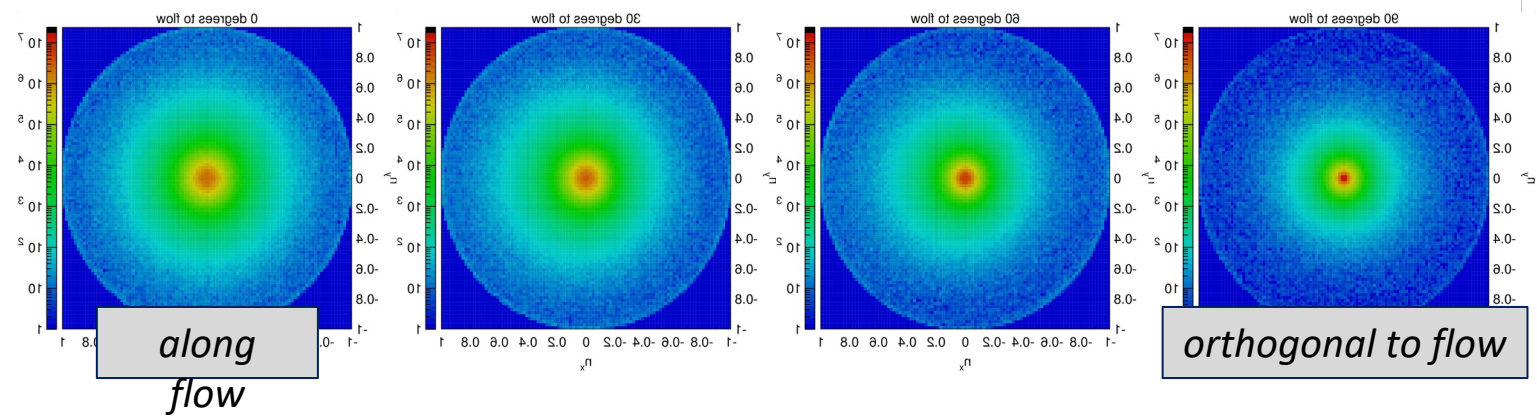
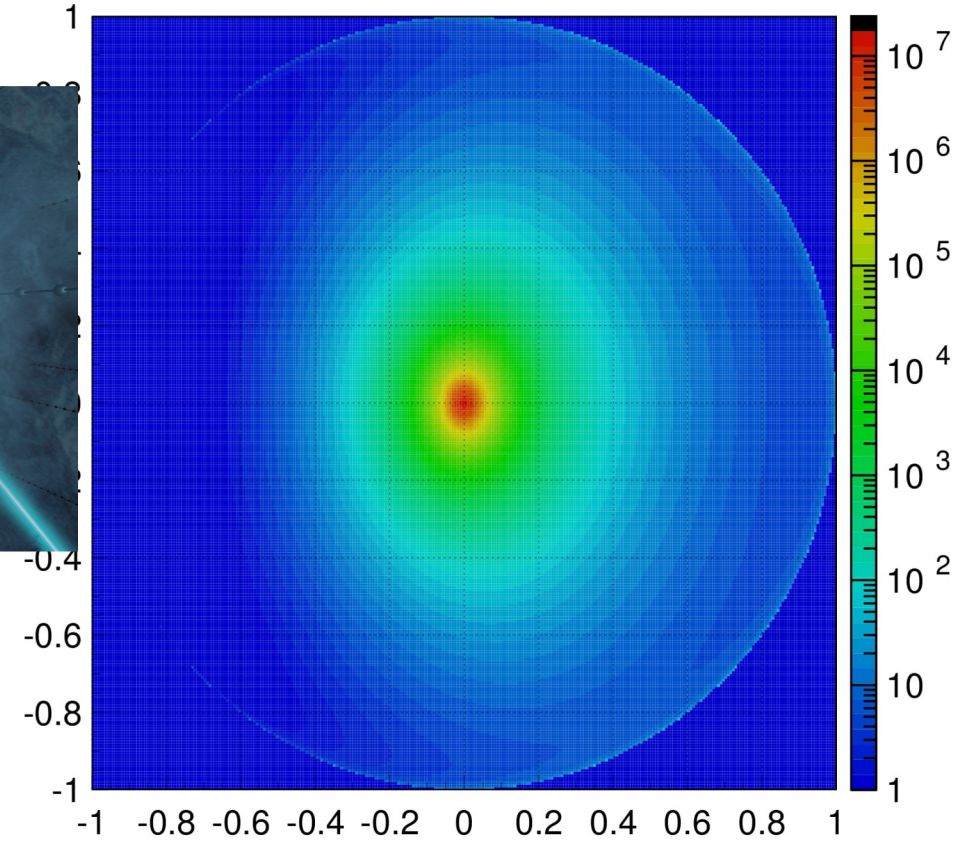

Birefringence

DOM pairs on nearby strings along flow axis

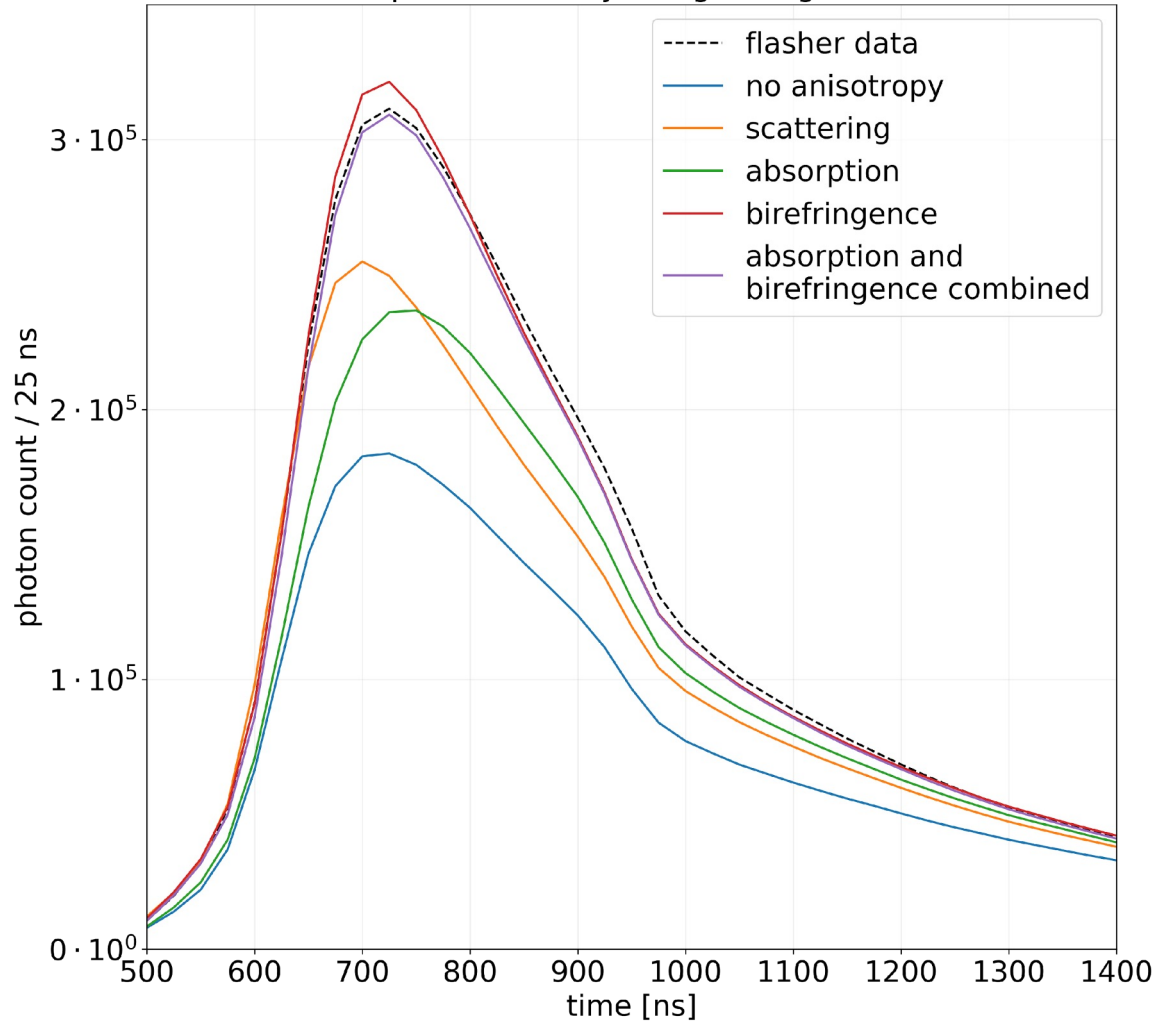

DOM pairs on nearby strings roughly perpendicular to flow axis

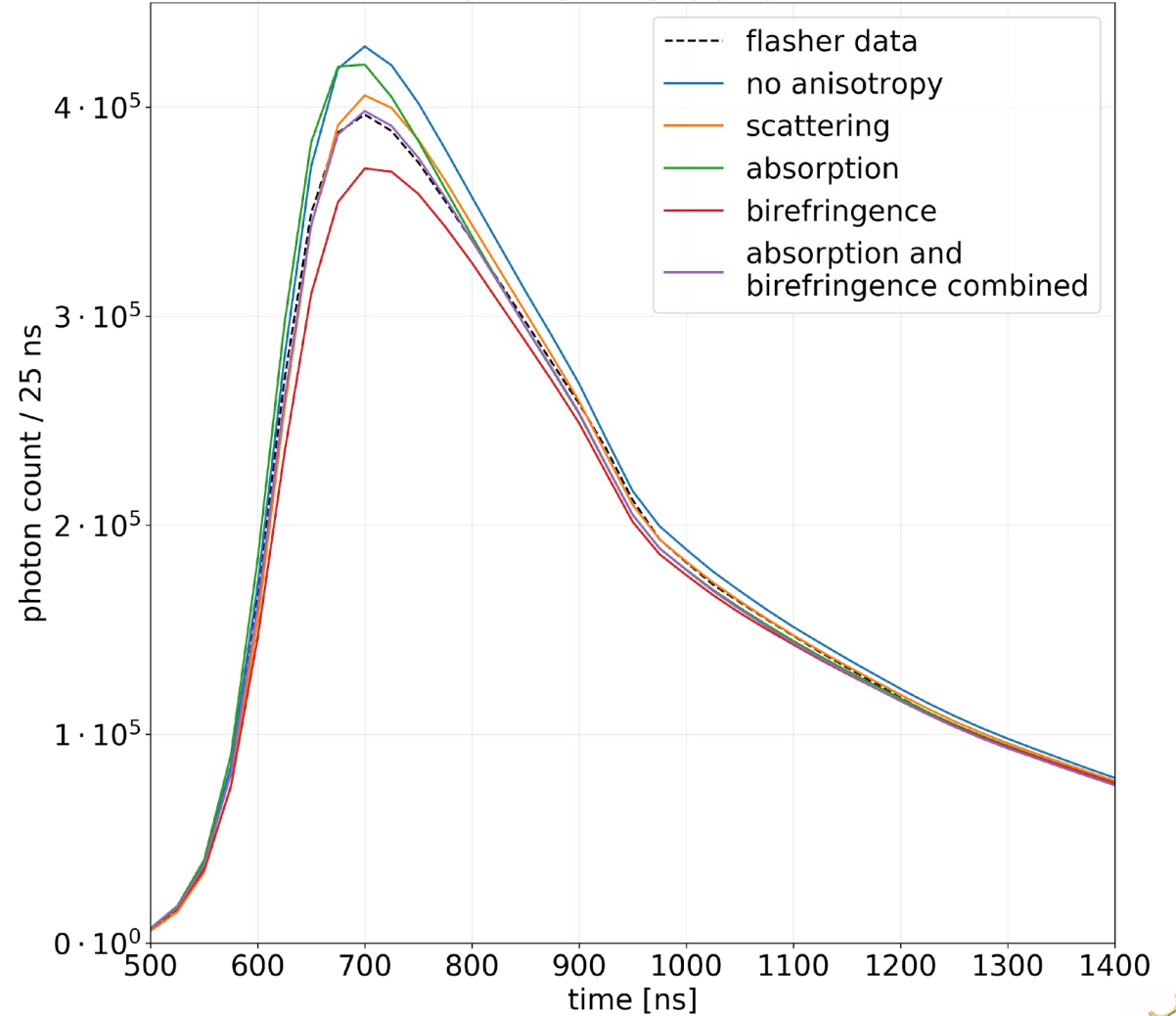

Ice model with birefringence gives the best agreement between LED flasher data and simulation



Full Tilt Parameterization

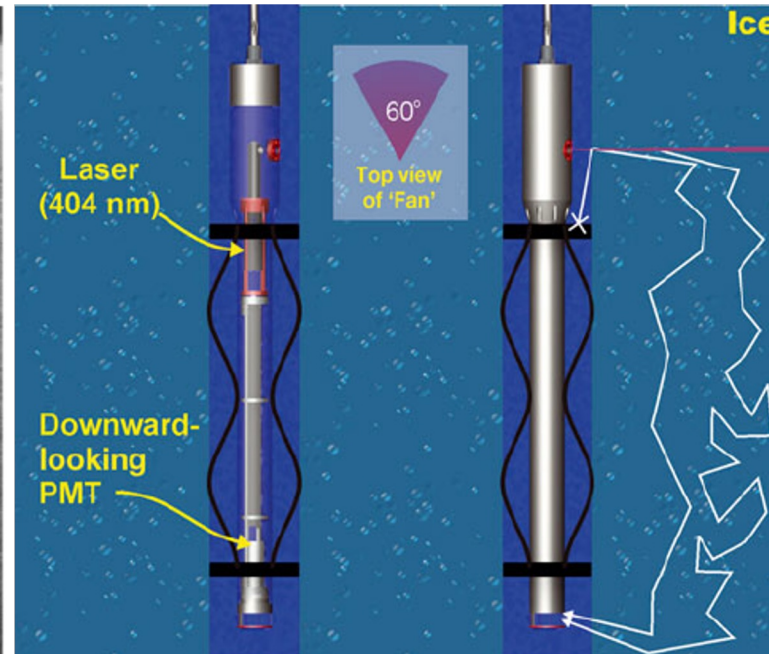
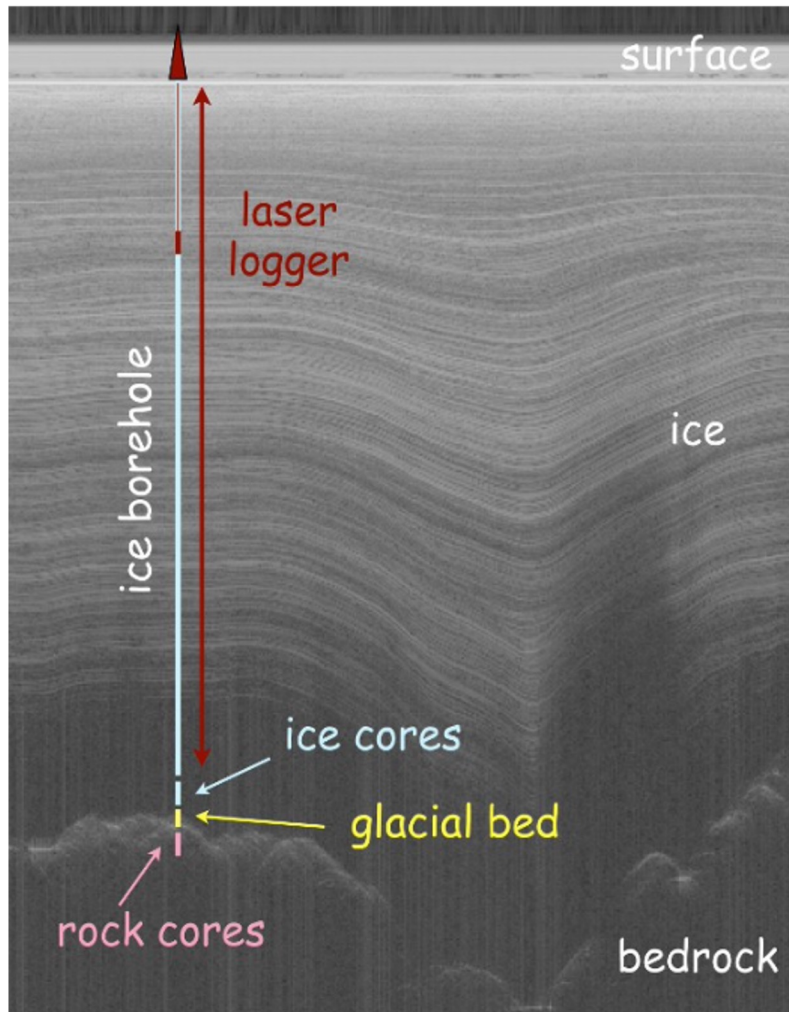

Dust layer tilt formerly modeled with data from “dust loggers” deployed during construction, now using fully volumetric tilt model derived from LED flasher data

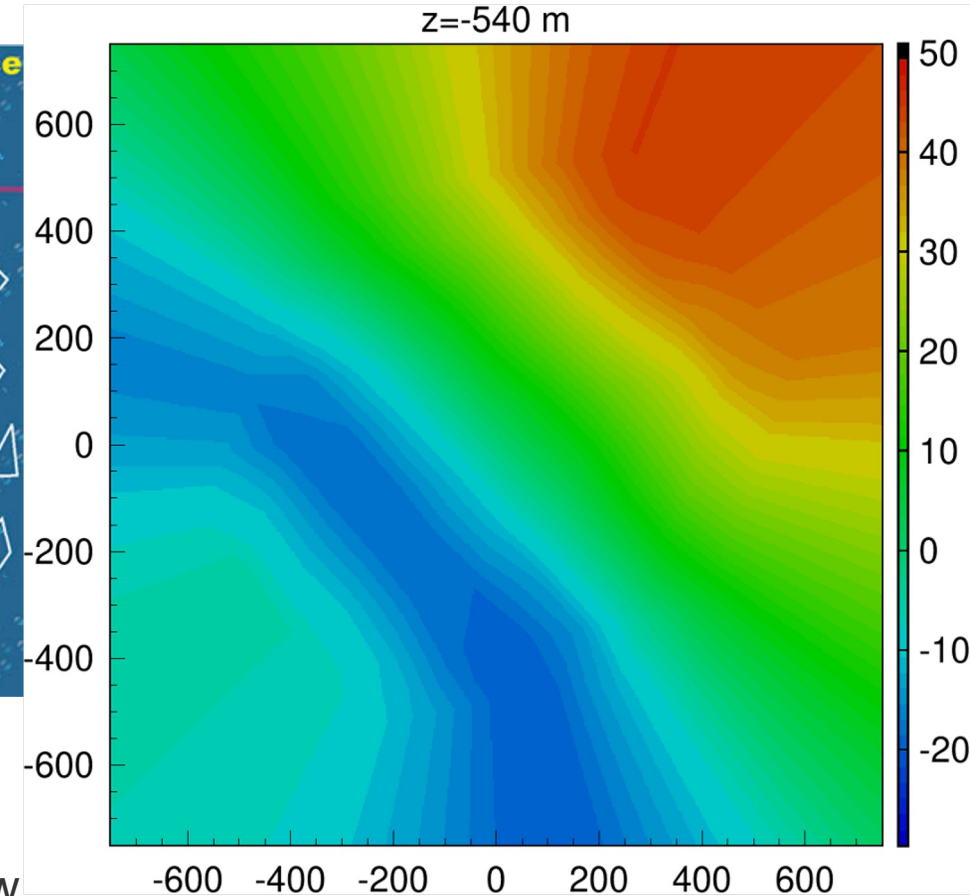

PoS-ICRC2023-975

Relative DOM Efficiency

bfr w/HI fit

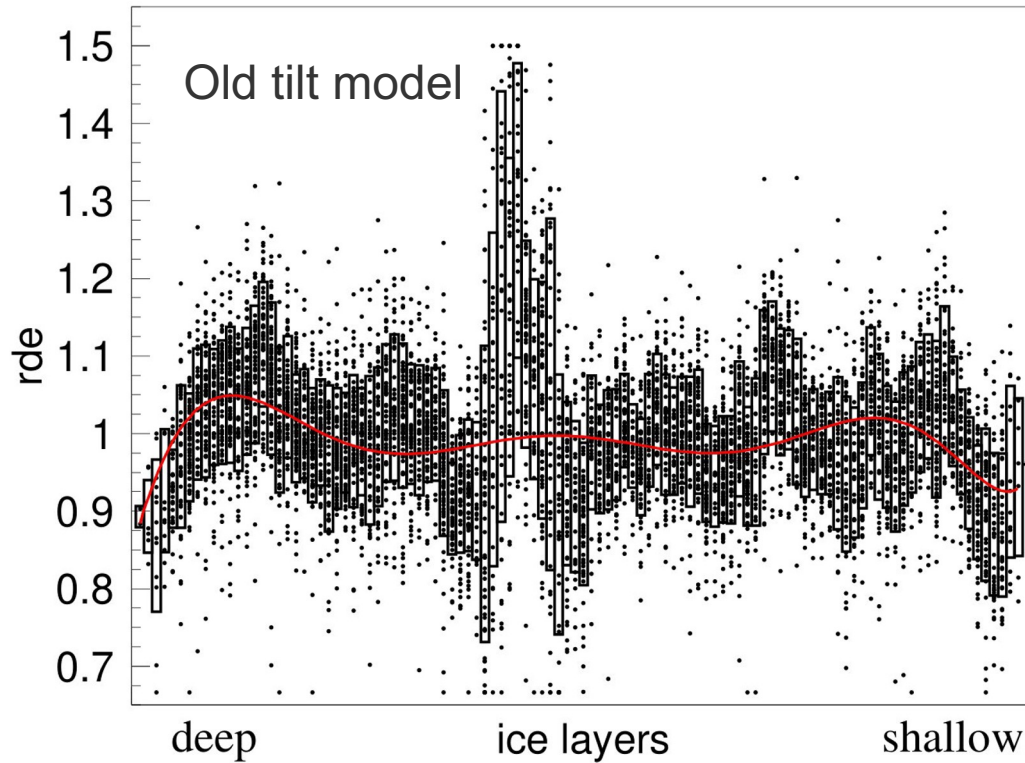

1-comp, iter=2

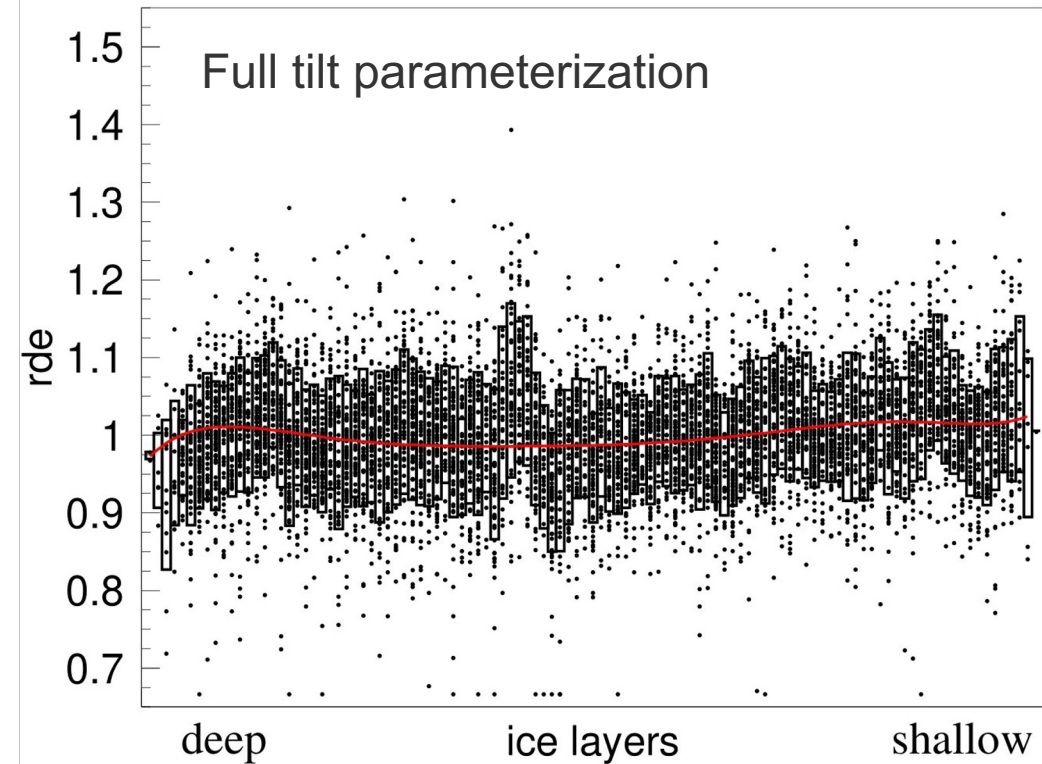

Simulation round trip tests indicate that the ice model can still be improved
 Recent work: measurement of RDE with the FTP ice model shows improvement,
 significant reduction of depth dependence seen in old model

Calibration Devices in the Upgrade

Onboard D-Eggs, mDOMs and pDOMs:

- LED flashers
- Fixed focus cameras and illumination LEDs
- Mainboard-mounted magnetometers & accelerometers

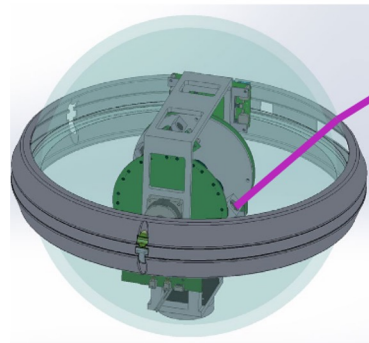
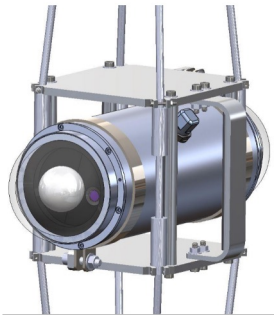
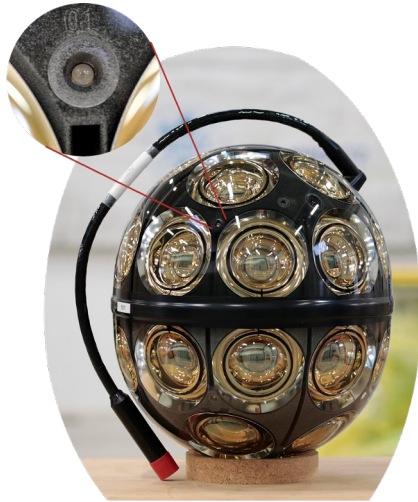

PencilBeam,
UW Madison



Acoustic Module, RWTH
Aachen

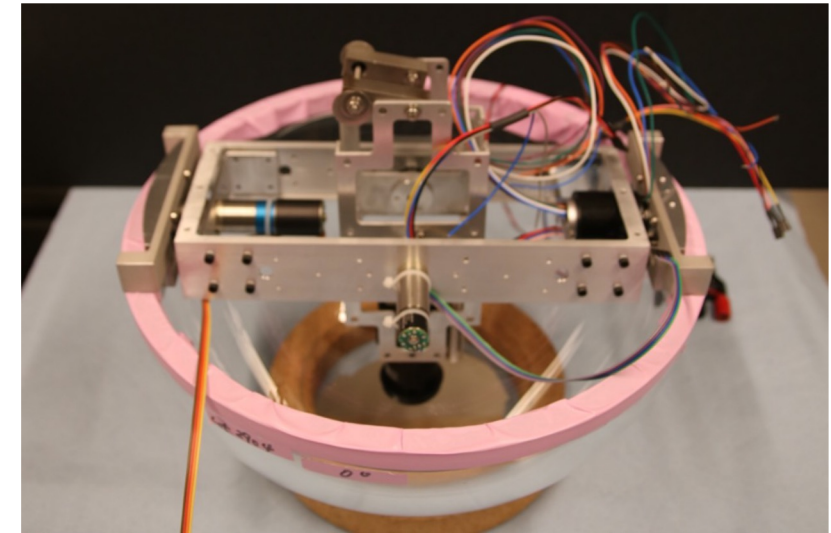

Sweden Camera 2.0,
Stockholm and Uppsala



Calibration Devices in the Upgrade

POCAM is an isotropic light source using diffused LED light: hole ice and module efficiency

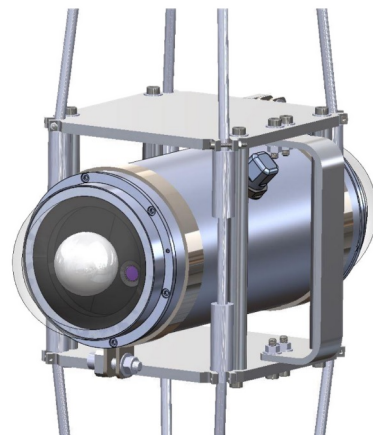
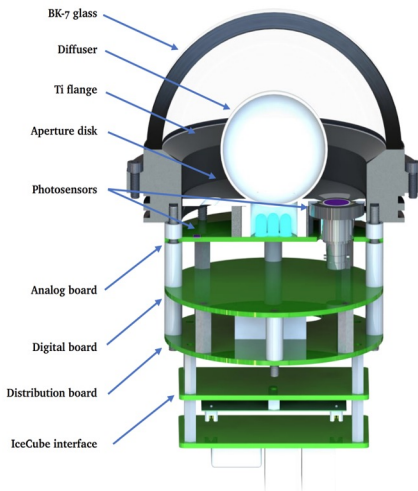

PencilBeam is a steerable collimated light source: scattering function and birefringence

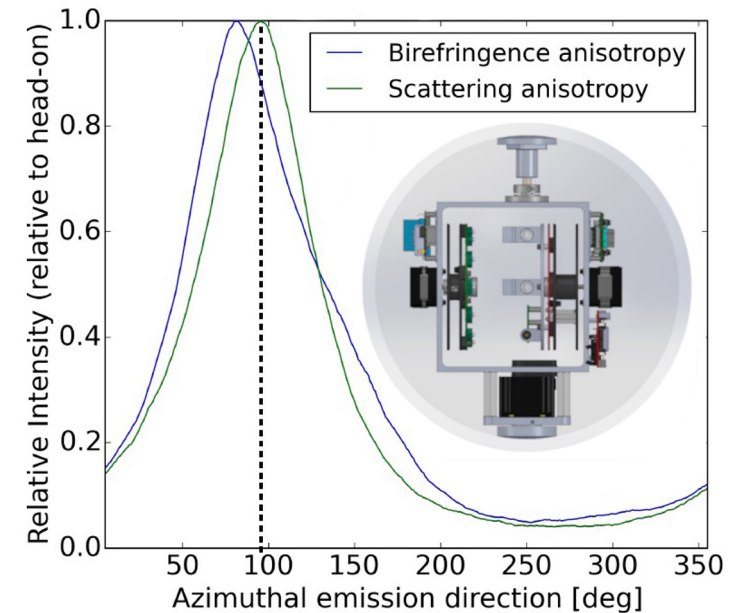

Calibration Devices in the Upgrade

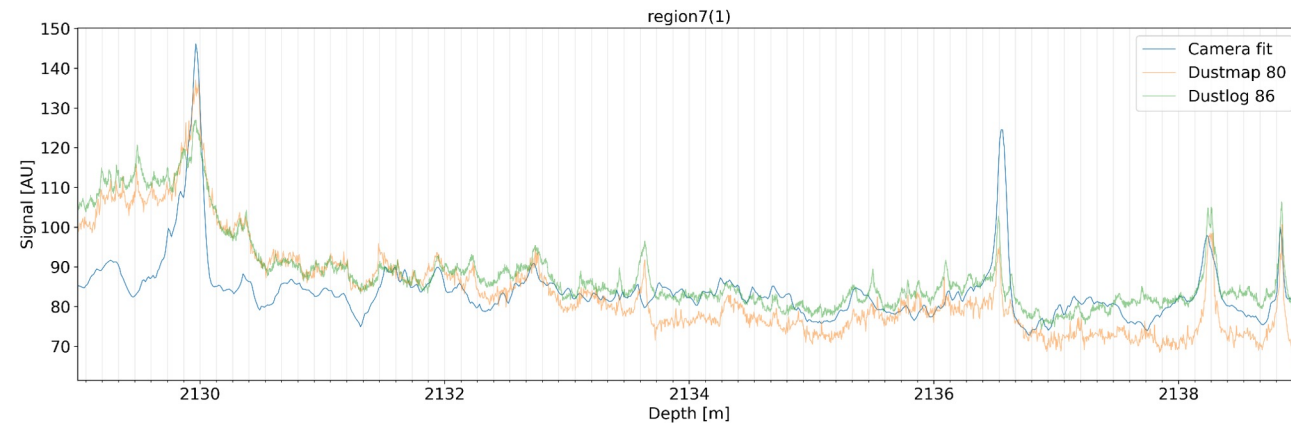
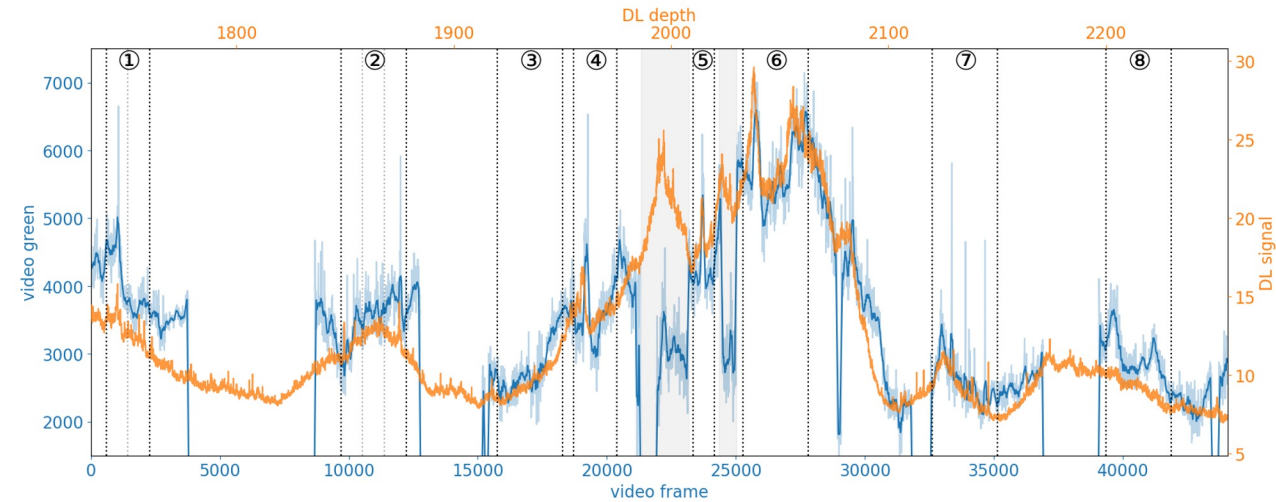
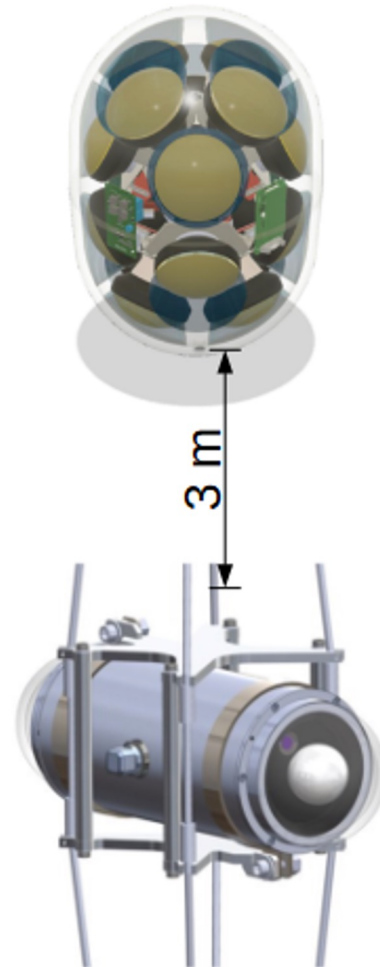
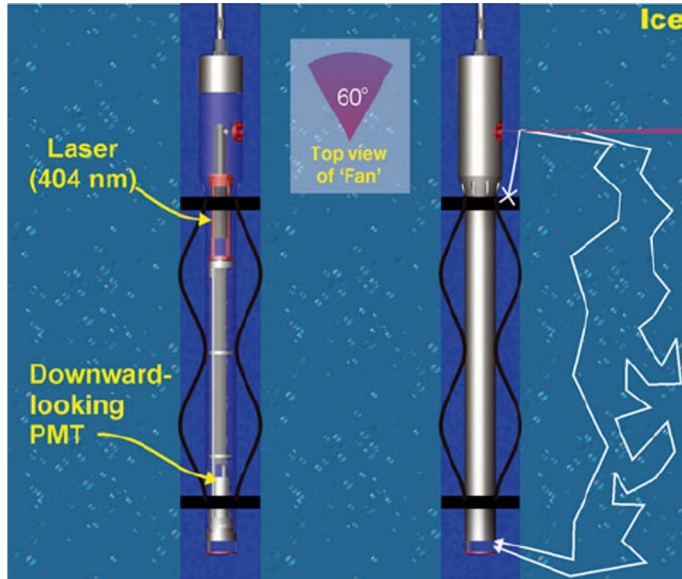



Dust layer stratigraphy measurements:

- Deploy dust logger as used in Gen 1
- Use modified POCAM as a line laser light source
- Analyze Sweden camera data recorded during descent

Upgrade calibration goals

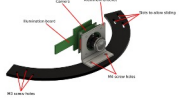
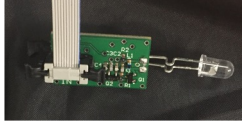
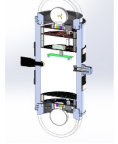
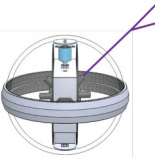
1. Upgrade timing and geometry measurements
2. DOM optical efficiency determination *in situ* to better than 3%
3. 2x reduction in uncertainty due to refrozen hole ice
4. Determine the source and depth dependence of ice optical anisotropy
5. Measure acoustic properties of bulk ice for Gen2
6. Measure properties of ice below IceCube instrumented volume

Device	Goal
Cameras 	3
Flashers 	1, 6
POCAM 	2, 3, 6
PencilBeam 	4, 6
Acoustic Modules 	1, 5, 6
Dust Logging devices	4, 6

Calibration in the IceCube Upgrade

Device	IceCube	IceCube Upgrade	Note
Flasher LEDs in DOMs	All DOMs	All DOMs	Upgrade spacing will be below one effective scattering length
Cameras	1 standalone camera, not onboard DOM	Onboard DOMs, additional standalone cameras	Camera has been very useful in informing us about hole ice conditions
Standalone light sources	2 laser "standard candles"	POCAM and Pencil Beams on each string	POCAM and Pencil beam designed to be isotropic/multidirectional and probe hole ice and scattering function respectively
Acoustic Modules	None	Acoustic Modules on each string	Cross-check geometry measurements, R&D for extended detector calibration
Inclinometers	50	All DOMs	Mainboard mounted off the shelf component



Summary

- Detector instrumentation is very stable
- Measurement of DOM sensitivity and geometry continues to be improved
- Understanding of the ice model has made major progress, still more to be learned
- The Upgrade will deliver an unprecedented wealth of detail on the ice and answer outstanding questions on the deep ice, hole ice, and anisotropy

Backup



Latest progress on ice model

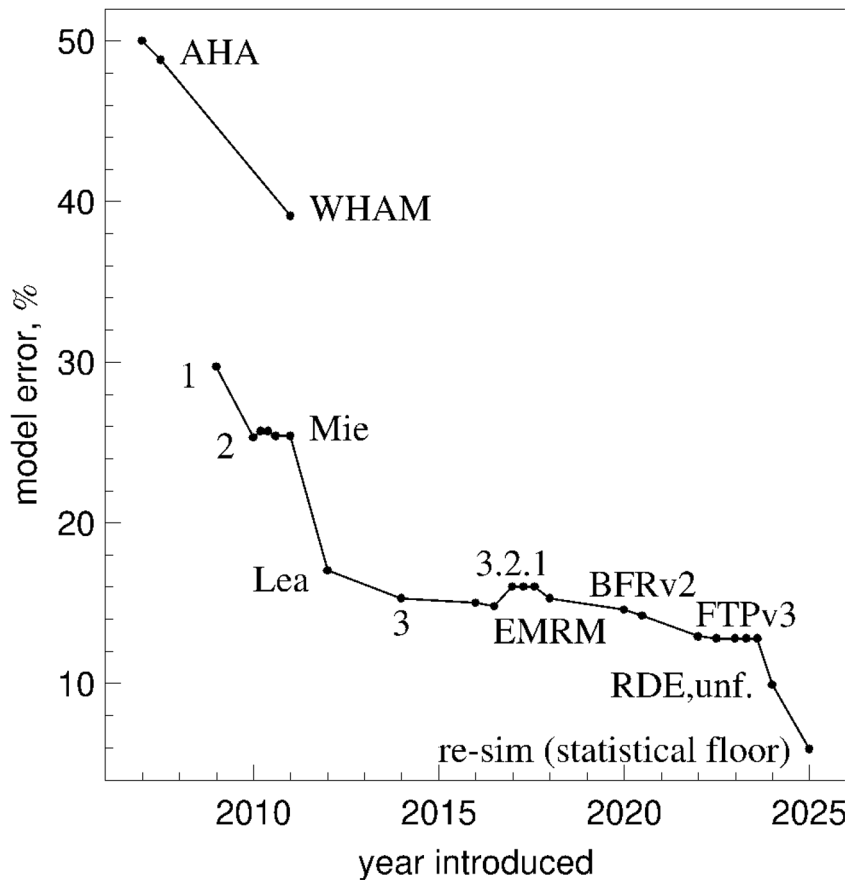

AMANDA ice models:

model error
 bulk, f125, mam, mamint, stdkurt, sudkurt, kgm, ...
 millennium (published 2006) ☐ AHA (2007)
 55%

IceCube ice models:

WHAM	(2011)	42%
SPICE 1	(2009)	29%
SPICE 2, 2+, 2x, 2y	(2010)	added ice layer tilt
SPICE Mie	(2011)	fit to scattering function
SPICE Lea	(2012)	fit to scattering anisotropy
SPICE (Munich)	(2013)	7-string, LED unfolding
SPICE ³ (CUBE)	(2014)	lh fixes, DOM sensitivity
SPICE 3.0	(2015)	improved RDE, ang. sens.

fits

fits